

# GESCOVA

OUTDOOR FURNITURE



**GESCOVA**  
OUTDOOR FURNITURE

*Happiness is found in the moments we share!*

# Gescova, Belgian Designers of Outdoor Happiness

Dear Partner,

**The Gescova story is woven with the ambition to establish an internationally recognized outdoor brand, rooted in our Belgian family heritage. Collaboration stands as the cornerstone of our success, driving us to engage with a network of agents and distributors to share our vision of 'Belgian Designed Outdoor Happiness' across Europe.**

We take pride in presenting our collection, a culmination of global exploration to translate Belgian design into a diverse range of over 600 references. Each item embodies our unwavering 100% commitment as a family, showcasing our dedication to quality, attention to detail, and innovative design. Our assortment is crafted to offer a broad spectrum of customers the opportunity to savor precious outdoor moments of togetherness with friends and family—a value increasingly cherished in contemporary society.

Recognizing the evolving preferences of our customers, we complement our extensive selection with a suite of potent sales tools. Our catalog, born from meticulous photo shoots in unique locations featuring friends of the family as models, seeks to encapsulate the essence of our brand experience on paper. To convey the tangible quality of our products, we've developed a sample box, enabling you and your customers to authentically experience the materials and fabrics.

In the digital realm, we stay abreast with a library of hundreds of pre-prepared social media posts for Instagram and Facebook, poised to capture the digital hearts of your customers. Our updated website, coupled with the development of a digital ordering platform, facilitates real-time inventory tracking and order placement. This empowers you to seamlessly access our 25,000 m<sup>2</sup> inventory, enabling sales at any time without the hassle of managing your own stock.

We've invested in expanding our showroom to 2,500 m<sup>2</sup>, extending an open invitation for your training, introductions, or sales meetings with your customers.

Our determination to realize this ambitious plan is mirrored in our substantial investment in what we consider our Gescova family. With all the tools at our disposal, let's harness this momentum to create success together. We eagerly anticipate our upcoming meeting to discuss how we can continue building success together and bringing more "outdoor happiness" to customers.

With warm regards, Bernard, Frederik, Thomas, and Sammy Gesquière

## Gescova, créateurs belges du bonheur en plein air

Cher partenaire,

**L'histoire de Gescova est ancrée dans l'ambition de construire une marque outdoor internationalement reconnue, basée sur nos fondations familiales belges. La collaboration est la clé de notre succès, c'est pourquoi nous travaillons avec un réseau d'agents et de distributeurs pour diffuser avec passion la vision du "Belgian Designed Outdoor Happiness" à travers l'Europe.**

Nous sommes fiers de présenter notre collection, fruit d'une recherche globale visant à traduire le design belge en une gamme étendue de plus de 600 références différentes. Chaque article représente notre engagement à 100% pour la recherche de la meilleure qualité par le détail et le design. Nous avons créé des collections qui invitent un large éventail d'utilisateurs, à vivre en famille, en plein air, des moments précieux de convivialité, ce qui est considéré comme de plus en plus important dans notre société.

Conscients de l'évolution de nos clients, nous proposons une large gamme de produits, ainsi qu'une série de puissants supports de vente. Notre catalogue, fruit de séances photos appliquées dans des lieux uniques avec des amis proches de la famille, vise à capturer l'essence de l'âme de notre marque. Pour montrer et partager la bonne qualité de nos produits, nous avons conçu une boîte d'échantillons qui vous permet, à vous et à votre client, de découvrir les matières et les tissus.

Sur le plan numérique, nous ne sommes pas en reste, avec une bibliothèque de centaines de posts préparés pour les médias sociaux, nous sommes prêts à conquérir les cœurs de vos clients. Avec notre site web, nous avons mis à votre disposition, une plateforme de commande numérique. Cette plateforme vous permettra de suivre les stocks en temps réel et de passer des commandes. Notre stock de 25 000 m<sup>2</sup>, vous deviendra encore plus accessible, et vous permettra de vendre à tout moment et sans avoir à gérer vos propres stocks.

Nous avons investi dans l'agrandissement de notre salle d'exposition de 2 500 m<sup>2</sup>, où vous êtes toujours les bienvenus pour des présentations, formations ou des réunions de vente avec vos clients. Nous sommes déterminés à réaliser un projet audacieux en investissant massivement dans Gescova que nous considérons avec vous comme notre famille Gescova. Tous les outils sont à notre portée, utilisons cet élan pour créer le succès ensemble. Nous nous réjouissons de vous rencontrer bientôt et de partager ensemble notre coopération vers le succès afin d'amener vos clients vers « plus de bonheur en plein air »

Avec nos chaleureuses salutations, Bernard, Frederik, Thomas et Sammy Gesquière

## Gescova, Belgian Designers of Outdoor Happiness

Beste partner,

**Ons Gescova verhaal is geworteld in de ambitie om een internationaal erkend outdoor merk op te bouwen, gebaseerd op onze Belgische familiale fundamenteën. Samenwerken is de sleutel tot ons succes en daarom verbinden we ons met een netwerk van agenten en verdelers om vol passie de visie 'Belgian Designed Outdoor Happiness' te verspreiden over Europa.**

Met trots presenteren we onze collectie, het resultaat van een wereldwijde ontdekkingsstocht om Belgisch design te vertalen in een uitgebreid assortiment van meer dan 600 verschillende referenties. Elk artikel vertegenwoordigt onze 100% inzet als familie, onze zoektocht naar de beste kwaliteit, oog voor details en design. We hebben een assortiment samengesteld dat een breed scala aan klanten uitnodigt om kostbare momenten van samenzijn te beleven, om buiten te zijn met vrienden en familie - iets wat steeds waardevoller wordt geacht in onze samenleving.

We erkennen dat onze klanten evolueren en daarom bieden we, naast een breed assortiment, een reeks krachtige verkoopstools aan. Onze catalogus, het resultaat van zorgvuldige fotoshoots op unieke locaties, en met vrienden van de familie als modellen, beoogt de essentie van onze merkbeleving op papier te vangen. Om de tastbare kwaliteit van onze producten te delen hebben we een stalenbox ontworpen die u en uw klant in staat stelt de materialen en stoffen echt te ervaren.

Digitaal blijven we niet achter, met een bibliotheek van honderden voorbereide social media posts voor Instagram en Facebook staan we klaar om het digitale hart van uw klanten te winnen. Onze website is up-to-date gebracht en we zetten een digitaal bestelplatform op. Dit platform stelt u in staat de voorraad in real time te volgen en bestellingen te plaatsen, waardoor onze voorraad van 25.000 m<sup>2</sup> nog toegankelijker wordt en u in staat stelt om altijd en zonder eigen voorraadbeheer te verkopen.

We hebben geïnvesteerd in onze uitgebreide showroom van 2500 m<sup>2</sup>, waar u altijd welkom bent voor training, kennismaking of verkoopgesprekken met uw klanten.

We hebben de vastberadenheid om dit gedurfd plan te realiseren door fors te investeren in wat we beschouwen als onze Gescova-familie. Alle tools zijn binnen handbereik, laten we dit momentum benutten om samen succes te creëren.

We kijken ernaar uit om elkaar snel te ontmoeten en te luisteren hoe wij samen verder aan jullie succes kunnen bouwen en de klanten kunnen meenemen naar meer 'outdoor happiness'.

Met warme groeten, Bernard, Frederik, Thomas en Sammy Gesquière







## The Heritage

### 1977: The Roots

The Gescova story began nearly 50 years ago in 1977 when Bernard Gesquière launched his business at the age of 19. Hailing from a typical Belgian flax family, the enterprise began under the name Golden River, paying homage to the river on the Lys, along which the flax industry thrived for years. Fabric and design became the enduring themes of the Gesquière family's narrative.

### 1982: The Atelier

Initially focusing on garden cushions, Bernard sourced fabrics from the heart of the European textile industry. His keen eye for detail and quality, supported by his wife Grietje's discerning judgment, led to early success. Inspired, the duo established their own atelier where about 10 seamstresses initially crafted the pillows by hand—an expertise passed down from mother to daughter in the region.

### 1990: Garden Furniture

Sales and production grew, necessitating a strong brand. The GESCOVA brand emerged, expanding the range from cushions to include garden furniture and parasols. This set the tone for offering compelling commercial and Belgian design through a network of stores across the country.

### 1995: Belgian Design

As the market evolved, Gescova innovatively responded to changing customer living trends. Customers sought the same comfort outdoors as indoors, transforming the terrace into an extension of the living room. The appreciation for Belgian design combined with new materials worldwide, with teak wood from Indonesia taking a prominent role.

### 2002: The Family

The new generation, beginning with Frederik and followed by Thomas and Sammy, entered with an ambitious vision. Extensive travels globally provided inspiration to discover the best ideas, make informed material choices, and establish exclusive collaborations with experts and suppliers worldwide. This new generation injected fresh energy while upholding strong traditions.

### 2008: 20 European Countries

Gescova expanded beyond Belgium, presenting its furniture at international fairs for the first time. Foreign agents were appointed, contributing to Gescova's growth as an international outdoor brand. The ambition expanded to be active in 20 countries, viewing agents and distributors as integral members of the Gescova family—success achieved through collaborative effort.

### 2010: Room for Growth

Remaining true to its roots, Gescova acquired the 25,000 m<sup>2</sup> textile factory Plush at Wevelgem airport. Alongside an innovation center and an experience showroom to further develop its identity, a logistics center was built. Logistics, in addition to design, became a vital pillar in the brand's expansion, offering optimal accessibility for customers across Europe, distinguishing the brand's unique strengths. European customers could now sell without maintaining their own stock.

### 2014: Partners in Asia

Recognizing the importance of having a substantial stock, Gescova successfully identified exclusive factories in Asia to produce their designs. This strategic move ensured the success of maintaining a large inventory.

### 2018: Digital Inspiration

As customer behaviors shifted towards digital inspiration, Gescova embraced the digital realm while acknowledging the importance of tactile experiences. The brand's online presence on the website and social media aimed to help distributors and agents position the brand effectively. Digital discovery was complemented by the continued development of a European network of showrooms where customers could experience the products firsthand.

### 2024: Gescova, Belgian Designed Outdoor Happiness

Gescova emerges as a robust brand, leveraging its Belgian textile roots and 50 years of experience to develop unique expertise in creating indoor-like experiences outdoors with high-quality outdoor furniture. Through an international network of customers and selected suppliers, Gescova brings forth a diverse range for the new consumer. The brand is poised to champion and spread outdoor happiness across Europe.

## L'Héritage

### 1977 : les racines

L'histoire de Gescova a commencé il y a près de 50 ans, en 1977, lorsque Bernard Gesquière a créé sa propre entreprise à l'âge de 19 ans. Issu d'une famille de liniers typiquement belge, l'entreprise démarre sous le nom de Golden River, d'après la rivière de la Lys, le cours d'eau sacré le long duquel l'industrie du lin a prospéré pendant des années. Le tissu et le design seront le fil conducteur de l'histoire de la famille Gesquière.

### 1982 : L'atelier

Bernard se concentre d'abord sur les coussins de jardin. Il achète les tissus dans la région, cœur de l'industrie textile européenne. Il avait le souci du détail et de la qualité, soutenu en cela par l'œil critique de sa femme Grietje. Le succès rapide a incité le duo à construire son propre atelier où, à l'origine, une dizaine de couturières fabriquaient les coussins à la main. Un savoir-faire transmis de mère en fille dans la région.

### 1990 : Meubles de jardin

Les ventes et la production augmentent et nécessitent un nom fort. La marque GESCOVA est lancée. La gamme de coussins est étendue aux meubles de jardin et aux parasols. Cela donne le ton pour offrir un design commercial et belge fort dans un réseau de magasins à travers le pays.

### 1995 : Design belge

Le marché évolue et Gescova répond toujours de manière innovante aux tendances de vie de ses clients. Les clients de Gescova recherchent le même confort à l'extérieur qu'à l'intérieur. La terrasse devient de plus en plus une extension du salon. Le sens du design belge issu de ses racines flamandes est combiné à de nouveaux matériaux provenant du monde entier, le teck d'Indonésie jouant un rôle prépondérant.

### 2002 : La famille

La nouvelle génération arrive avec une vision ambitieuse. Le premier est Frederik, suivi de Thomas et de Sammy. De nombreux voyages autour du monde sont une source d'inspiration pour découvrir les meilleures idées, faire les bons choix de matériaux et mettre en place des collaborations exclusives avec des experts et des fournisseurs du monde entier. La nouvelle génération apporte un vent nouveau et le combine avec la solide tradition.

## **2008 : 20 pays européens**

L'heure n'est plus seulement à la Belgique. Pour la première fois, les meubles Gescova sont présentés lors de salons internationaux. Des agents étrangers sont nommés et contribuent à faire de Gescova une marque internationale de produits d'extérieur. Gescova continue à développer ce réseau avec l'ambition d'être actif dans 20 pays. Chez Gescova, les agents et les distributeurs font partie de la famille. Le succès vient du travail en commun et du partage avec les autres.

## **2010 : Place à la croissance**

Gescova reste fidèle à ses racines et achète l'usine textile Plush de 25 000 m<sup>2</sup> à l'aéroport de Wevelgem. Outre le centre d'innovation et la salle d'exposition où la marque peut développer son identité, elle y construit un centre logistique. Outre le design, la logistique sera un pilier important de l'expansion de la marque. L'accessibilité optimale pour tous les clients en Europe devient l'une des forces uniques de la marque. Les clients de toute l'Europe peuvent désormais vendre sans avoir à stocker eux-mêmes.

## **2014 : Partenaires en Asie**

Conscient de l'importance de disposer d'un stock important, Gescova recherche avec succès des usines en Asie qui sont prêtes à produire exclusivement les créations de Gescova. Cela garantit le succès de leur stock important.

## **2018 : L'inspiration numérique**

Les clients changent, ils sont de plus en plus inspirés par le numérique, mais ils aiment sentir ce qu'ils achètent. Gescova prend la vie numérique de ses clients très au sérieux et fournit l'expérience de la marque sur le site web et les médias sociaux. Cela devrait aider les distributeurs et les agents à mieux positionner la marque et permettre au consommateur final de trouver le produit là où il le cherche. La découverte numérique, mais le fait de sentir et de toucher le produit reste important. C'est pourquoi Gescova poursuit le développement d'un réseau européen de salles d'exposition où les produits peuvent être expérimentés.

## **2024 : Gescova, le bonheur extérieur conçu en Belgique**

Gescova devient une marque forte. De ses racines textiles belges et de ses 50 ans d'expérience est née une expertise unique sur la manière de créer la même expérience à l'extérieur qu'à l'intérieur avec des meubles d'extérieur de haute qualité. En collaboration avec un réseau international de clients et de fournisseurs sélectionnés, une large gamme est proposée aux nouveaux consommateurs. Gescova est prêt à prêcher le bonheur en plein air et à le répandre dans toute l'Europe.

# **The Heritage**

## **1977: De roots**

Het verhaal van Gescova begint bijna 50 jaar geleden in 1977, wanneer Bernard Gesquière op 19 jarige leeftijd zijn eigen zaak start. Als telg uit een typisch Belgische vlasfamilie startte de zaak onder de naam Golden River, vernoemd naar de rivier aan de Leie, de heilige stroom waarlangs jarenlang de vlasnijverheid had gefloreed. Stof en design zou een rode draad vormen door het verhaal van de familie Gesquière.

## **1982: Het Atelier**

Bernard focuste zich in het begin op tuinkussens. De stoffen kocht hij aan in de streek, het hart van de Europese textielnijverheid. Hij had oog voor detail en kwaliteit, hierbij ondersteund door het kritisch oog van zijn vrouw Grietje. Het vroege succes inspireerde het duo om een eigen Atelier uit te bouwen waar aanvankelijk een 10-tal naaisters de kussens met de hand maakten. Een expertise die in de streek van moeder op dochter werd doorgegeven.

## **1990: Tuinmeubilair**

De verkoop en productie groeit en heeft nood aan een sterke naam. Het merk GESCOVA wordt op de kaart gezet. Het assortiment kussens wordt uitgebreid met tuinmeubilair en parasols. Dit zet de toon om sterk commercieel en Belgisch design aan te bieden in een netwerk van winkels over het hele land.

## **1995: Belgian Design**

De markt verandert en Gescova speelt steeds innovatief in op de leertrends van de klanten. De klanten van Gescova zoeken buiten hetzelfde comfort als binnen. Het terras wordt steeds meer het verlengstuk van de woonkamer. De feeling voor Belgisch design wordt vanuit de Vlaamse roots gecombineerd met nieuwe materialen van over de hele wereld, waarbij het teak hout uit Indonesië een prominente rol zal spelen.

## **2002: The Family**

De nieuwe generatie doet de intrede met een ambitieuze visie. Eerst komt Frederik, daarna volgen Thomas en Sammy. Vele reizen over de hele wereld zorgen voor inspiratie om de beste ideeën te ontdekken, de juiste materiaalkeuzes te maken en exclusieve samenwerkingen op te zetten met experts en toeleveranciers over de hele wereld. De nieuwe generatie brengt een nieuwe wind en combineert deze met de sterke traditie.

## **2008: 20 Europese landen**

Tijd voor meer dan alleen België. Voor het eerst werden de meubelen van Gescova voorgesteld op internationale beurzen. Buitenlandse agenten werden aangesteld en werkten mee aan de uitbouw van Gescova als internationaal merk voor outdoor. Gescova bouwt dit netwerk verder uit met de ambitie in 20 landen actief te zijn. Bij Gescova maken agenten en verdelers deel uit van de familie. Succes heb je door samen te werken en te delen met anderen.

## **2010: Ruimte voor groei**

Gescova blijft trouw aan haar roots en koopt de 25000 m<sup>2</sup> grote textiel fabriek Plush aan de luchthaven te Wevelgem. Ze bouwt er, naast haar innovatiecentrum en de belevingsshowroom waar het merk zijn identiteit verder kan laten uitgroeien, een logistiek centrum uit. Naast design wordt logistiek een belangrijke pijler in de uitbouw van het merk. Een optimale toegankelijkheid voor alle klanten in Europa wordt één van de unieke sterktes van het merk. Klanten van over heel Europa kunnen nu verkopen zonder zelf voorraad te hoeven houden.

## **2014: Partners in Azië**

Gescova beseft dat het belangrijk is om een grote voorraad ter beschikking te hebben en gaat met succes op zoek naar fabrieken in Azië, die exclusief de Gescova designs willen produceren. Dit zorgt ervoor dat het succes van hun grote voorraad gegarandeerd blijft.

## **2018: Digital Inspiration**

Klanten veranderen, ze laten zich steeds meer digitaal inspireren maar voelen graag wat ze kopen. Gescova neemt het digitale leven van haar klanten heel au sérieux en zorgt voor de beleving van het merk op website en social media. Het moet de verdelers en agenten helpen het merk beter te plaatsen en de eindconsument het product te laten vinden waar ze het zoeken. Digitaal ontdekken maar het product voelen en aanraken blijft belangrijk. Daarom werkt Gescova verder aan de uitbouw van een Europees netwerk van toonzalen waar de producten kunnen worden beleefd.

## **2024: Gescova, Belgian designed outdoor happiness**

Gescova wordt een sterk merk. Vanuit de Belgische textielroots en met 50 jaar ervaring groeide een unieke expertise over hoe je met kwalitatief outdoor meubilair dezelfde beleving kan maken buiten als binnen. Samen met een internationaal netwerk van klanten en geselecteerde leveranciers wordt een breed assortiment naar de nieuwe consument gebracht. Gescova is klaar om outdoor happiness te prediken en over heel Europa uit te dragen.





## MILA

Lounge set  
teak backrest, quick dry foam  
*Salon*  
*dos en teck, mousse séchage rapide*

- 98110** | 1-seat mario siesta ecru  
*canapé 1P mario siesta écreu*
- 98111** | corner seat mario siesta ecru  
*siège d'angle mario siesta écreu*
- 98112** | 2-seat mario siesta ecru  
*canapé 2P mario siesta écreu*

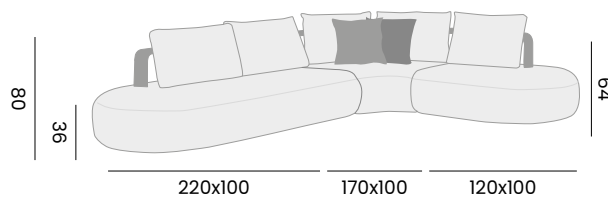

## SANTORINI

coffee table - *table basse*

- 97433** | teak, half moon  
*teck, demi lune*
- 97434** | teak, round  
*teck, ronde*

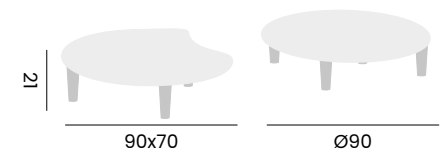



## RAFA

fabric agora, quick dry foam  
tissu agora, mousse séchage rapide

### 1-seat - *fauteuil*

- 97968** | teak - twitell IO + cushions, *teck - twitell IO + coussins*  
**98100** | teak - mario siesta ecru + cushions, *teck - mario siesta écru + coussins*

### 3-seat - *canapé 3P*

- 97969** | teak - twitell IO + cushions, *teck - twitell IO + coussins*  
**98101** | teak - mario siesta ecru + cushions, *teck - mario siesta écru + coussins*

### element - *unité 1P*

- 97970** | teak - twitell IO + cushions, *teck - twitell IO + coussins*  
**98102** | teak - mario siesta ecru + cushions, *teck - mario siesta écru + coussins*

### corner element - *unité de coin*

- 97971** | teak - twitell IO + cushions, *teck - twitell IO + coussins*  
**98103** | teak - mario siesta ecru + cushions, *teck - mario siesta écru + coussins*

### 3-seat, arm left - *canapé 3P accoudoir gauche*

- 97972** | teak - twitell IO + cushions, *teck - twitell IO + coussins*  
**98104** | teak - mario siesta ecru + cushions, *teck - mario siesta écru + coussins*

### 3-seat, arm right - *canapé 3P accoudoir droit*

- 97973** | teak - twitell IO + cushions, *teck - twitell IO + coussins*  
**98105** | teak - mario siesta ecru + cushions, *teck - mario siesta écru + coussins*

### longchair, arm left - *chaise longue accoudoir gauche*

- 97974** | teak - twitell IO + cushions, *teck - twitell IO + coussins*  
**98106** | teak - mario siesta ecru + cushions, *teck - mario siesta écru + coussins*

### longchair, arm right - *chaise longue accoudoir droit*

- 97975** | teak - twitell IO + cushions, *teck - twitell IO + coussins*  
**98107** | teak - mario siesta ecru + cushions, *teck - mario siesta écru + coussins*

### coffee table - *table basse*

- 97976** | teak - *teck*

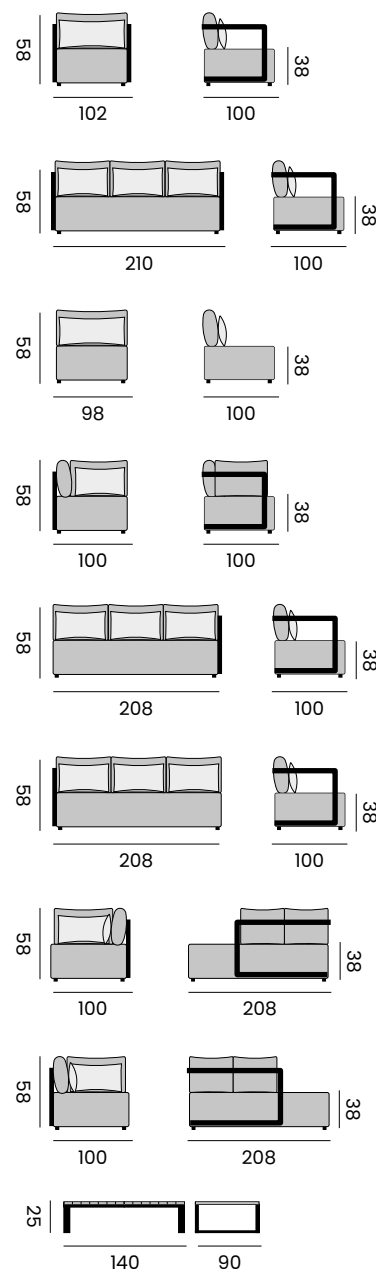





## RAFA

fabric agora, quick dry foam  
*tissu agora, mousse séchage rapide*

1-seat - *fauteuil*

**97980** | alu white - bruma niebla + cushions , *alu blanc - bruma niebla + coussins*

3-seat - *canapé 3P*

**97981** | alu white - bruma niebla + cushions , *alu blanc - bruma niebla + coussins*

element - *unité 1P*

**97982** | alu white - bruma niebla + cushions , *alu blanc - bruma niebla + coussins*

corner element - *unité de coin*

**97983** | alu white - bruma niebla + cushions , *alu blanc - bruma niebla + coussins*

3-seat, arm right - *canapé 3P accoudoir gauche*

**97984** | alu white - bruma niebla + cushions , *alu blanc - bruma niebla + coussins*

3-seat, arm left - *canapé 3P accoudoir droit*

**97985** | alu white - bruma niebla + cushions , *alu blanc - bruma niebla + coussins*

longchair, arm left - *chaise longue accoudoir gauche*

**97986** | alu white - bruma niebla + cushions , *alu blanc - bruma niebla + coussins*

longchair, arm right - *chaise longue accoudoir droit*

**97987** | alu white - bruma niebla + cushions , *alu blanc - bruma niebla + coussins*

coffee table - *table basse*

**97988** | alu white - *alu blanc*

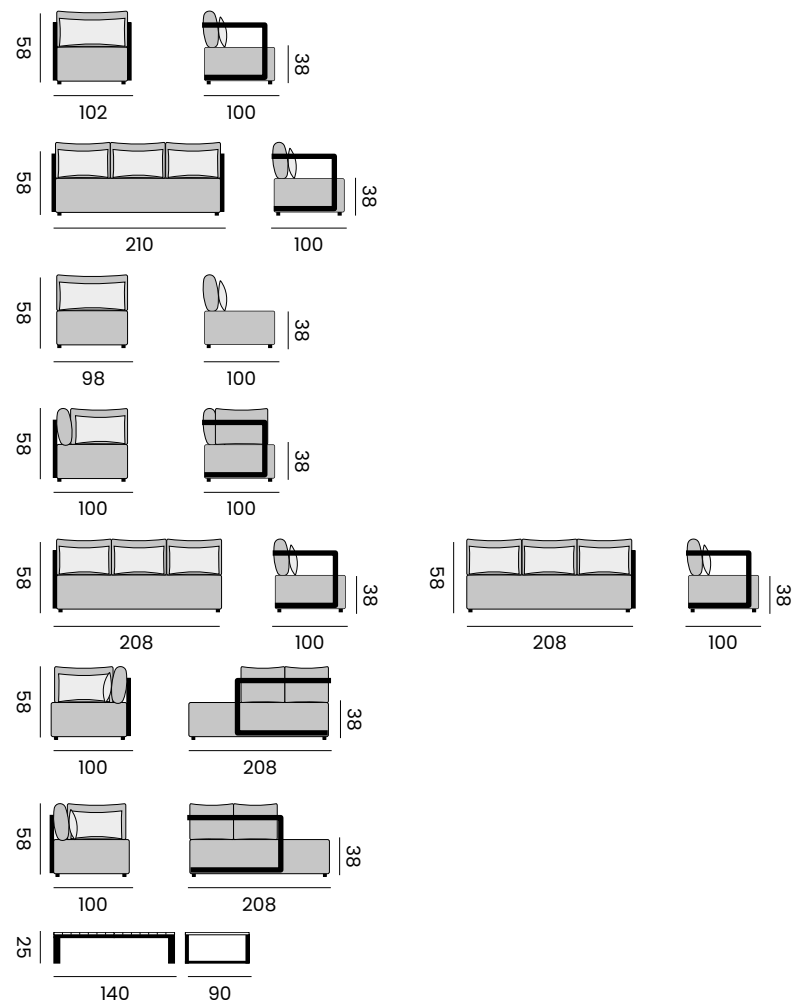



## TODO

fabric agora, quick dry foam  
*tissu agora, mousse séchage rapide*

3-seat, arm right - *canapé 3P accoudoir droit*

**98113** | alu charcoal - bruma dragon + cushions  
*alu charcoal - bruma dragon + coussins*

3-seat, arm left - *canapé 3P accoudoir gauche*

**98114** | alu charcoal - bruma dragon + cushions  
*alu charcoal - bruma dragon + coussins*

longchair, arm right - *chaise longue accoudoir droit*

**98115** | alu charcoal - bruma dragon + cushions  
*alu charcoal - bruma dragon + coussins*

longchair, arm left - *chaise longue accoudoir gauche*

**98116** | alu charcoal - bruma dragon + cushions  
*alu charcoal - bruma dragon + coussins*

element - *unité 1P*

**98117** | alu charcoal - bruma dragon + cushions  
*alu charcoal - bruma dragon + coussins*

2-seat - *canapé 2P*

**98118** | alu charcoal - bruma dragon + cushions  
*alu charcoal - bruma dragon + coussins*

coffee table - *table basse*

**98124** | alu charcoal - ceramic top  
*alu charcoal - plateau en céramique*

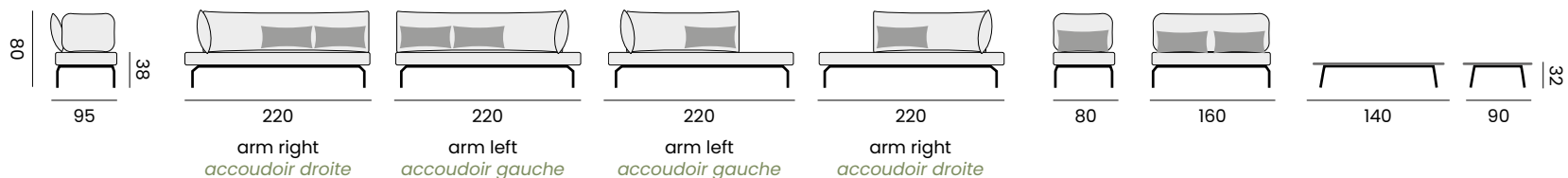





## FIORI

fabric agora, quick dry foam  
*tissu agora, mousse séchage rapide*

1-seat - *fauteuil*

**alu charcoal - senda dragon**

**97943** | seat element, *unité 1P*

**97946** | single backrest + striped cushion  
*unité dossier 1P + coussin rayé*

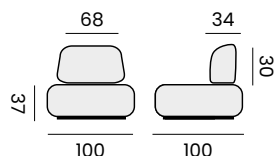

2-seat - *canapé 2P*

**alu charcoal - senda dragon**

**97944** | 2-seat element, *unité 2P*

**2x 97946** | single backrest + striped cushions  
*unité dossier 1P + coussins rayés*

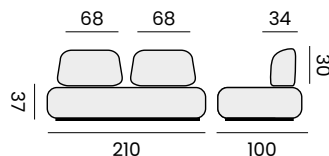

daybed - *lit de repos*

**alu charcoal - senda dragon**

**97945** | seat element, *unité 1P*

**97947** | double backrest + striped cushions  
*unité dossier double + coussins rayés*

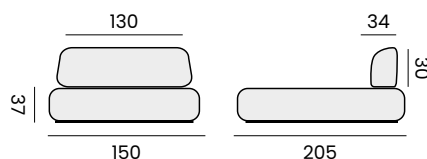

coffee table - *table basse*

**97967** | alu charcoal, ceramic charcoal  
*alu charcoal, céramique charcoal*

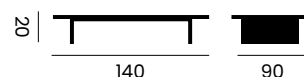

side table - *table d'appoint*

**97906** | alu white - *alu blanc*

**97913** | alu charcoal - *alu charcoal*

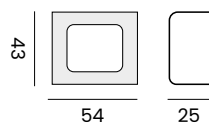



## AVENATTI

fabric agora, quick dry foam  
tissu agora, mousse séchage rapide

1-seat - *fauteuil*

**alu white - senda dragon**

**97900** | seat element, *unité 1P*

**97902** | backrest + cushion, *unité dossier + coussin*

**alu charcoal - senda sombra**

**97908** | seat element, *unité 1P*

**97910** | backrest + cushion, *unité dossier + coussin*

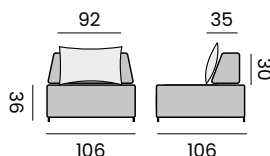

3-seat - *canapé 3P*

**alu white - senda dragon**

**97901** | seat element, *unité 3P*

**97904** | backrest, arm left + cushion  
*unité dossier 3P, accoudoir gauche+ coussin*

**97905** | backrest, arm right + cushion  
*unité dossier 3P, accoudoir droite + coussin*

**alu charcoal - senda sombra**

**97909** | seat element, *unité 3P*

**97912** | backrest, arm left + cushion  
*unité dossier 3P, accoudoir gauche+ coussin*

**97914** | backrest, arm right + cushion  
*unité dossier 3P, accoudoir droite + coussin*

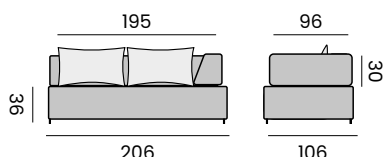

middle corner - *unité de coin*

**alu white - senda dragon**

**97900** | seat element, *unité de coin*

**97903** | backrest + cushion, *dossier + coussin*

**alu charcoal - senda sombra**

**97908** | seat element, *unité de coin*

**97911** | backrest + cushion, *dossier + coussin*

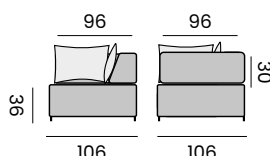

coffee table - *table basse*

**97906** | alu white, *alu blanc*

**97913** | alu charcoal, *alu charcoal*

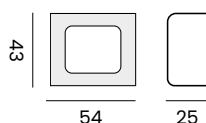

## FESTINI

fabric agora, quick dry foam  
*tissu agora, mousse séchage rapide*

1-seat - *fauteuil*

**97940** | senda dragon

3-seat - *canapé 3P*

**97941** | senda dragon

oval coffee table - *table basse ovale*

**97942** | ceramic white, senda dragon  
*céramique blanc, senda dragon*

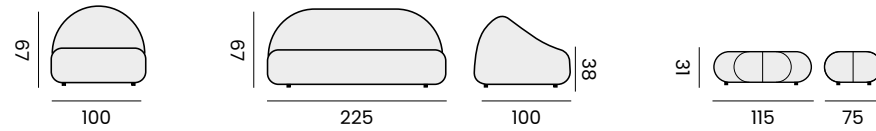



## BENITO

fabric agora, quick dry foam  
*tissu agora, mousse séchage rapide*

lounge seat - *siège lounge*

- 97924** | senda dragon light grey - *grise claire*
- 97926** | senda sombra dark grey - *grise foncée*

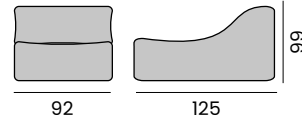

lounge footrest - *repose-pied lounge*

- 97925** | senda dragon light grey - *grise claire*
- 97927** | senda sombra dark grey - *grise foncée*

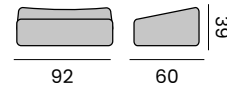

## TOTTI

fabric agora, quick dry foam, swivel  
*tissu agora, mousse séchage rapide, système de rotation*

1-seat - *fauteuil*

- 97999** | bruma niebla + 2 cushions + 1 pillow  
*bruma niebla + 2 coussins + 1 coussin déco*

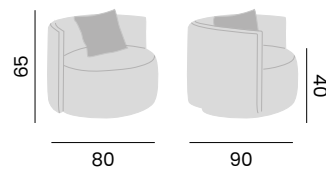

## SANTORINI

fabric sunproof , pillows green  
protection cover , quick dry foam  
*tissu sunproof , coussin déco vert*  
*housses de protection, mousse séchage rapide*

2-seat - *canapé 2P*

**97431** | teak, cushion natural  
*teck, coussin naturel*

3-seat - *canapé 3P*

**97432** | teak, cushion natural  
*teck, coussin naturel*

coffee table - *table basse*

**97433** | teak, half moon H21 L90 W70  
*teck, demi lune H21 L90 W70*

**97434** | teak, round H21 Ø90 W70  
*teck, ronde H21 Ø90 W70*

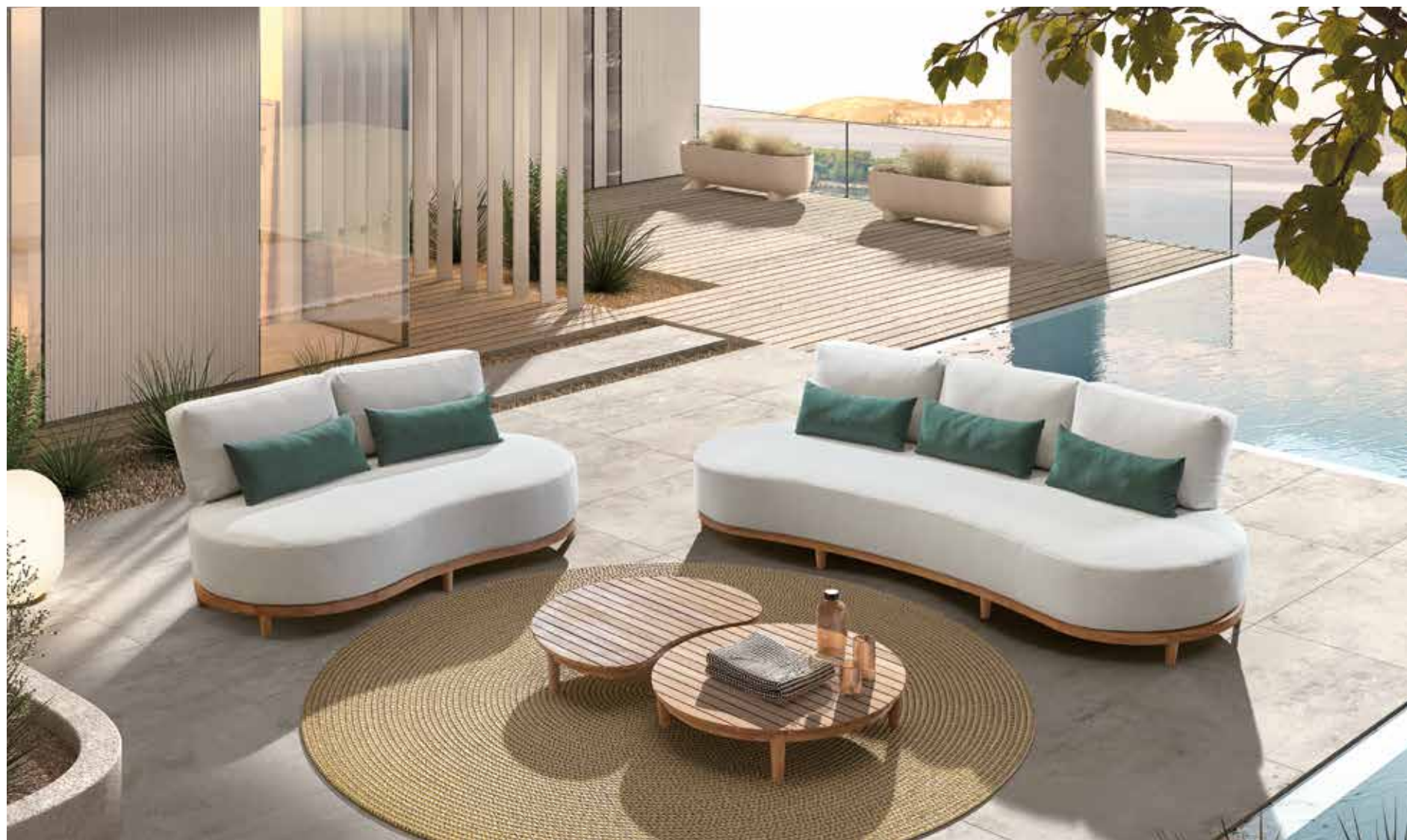
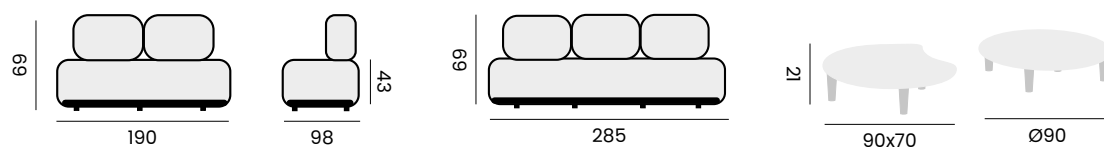



## FARO

3-seat, 2-seat with corner  
 coffee table, fabric sunproof, quick dry foam  
*canapé 3P, canapé 2P avec unité de coin  
 table basse, tissu sunproof, mousse séchage rapide*

lounge set - salon

**97419** | teak/alu backrest, cushion ecru  
 teck/dossier alu, coussin naturel

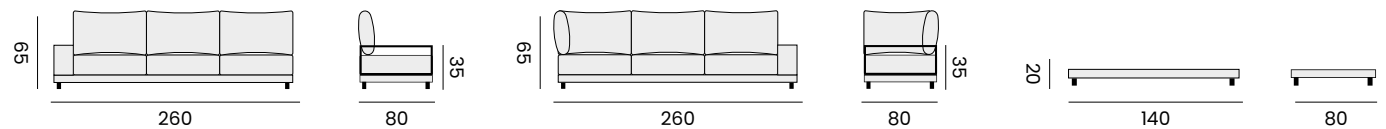

## CASABLANCA

fabric sunbrella, quick dry foam  
tissu sunbrella, mousse séchage rapide

1-seat - *fauteuil*

- 99984** | recycled teak, frame only  
*teck recyclé, **seulement la structure***
- 99996** | cushion set heritage leaf  
*set coussins heritage leaf*
- 99997** | cushion set heritage papyrus  
*set coussins heritage papyrus*



2-seat - *canapé 2P*

- 99985** | recycled teak, frame only  
*teck recyclé, **seulement la structure***
- 99998** | cushion set heritage leaf  
*set coussins heritage leaf*
- 99999** | cushion set heritage papyrus  
*set coussins heritage papyrus*

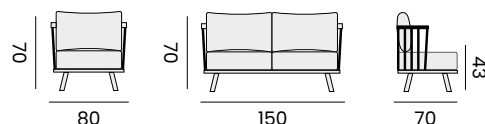

## FERDI

round coffee table, recycled teak  
*table basse ronde, teck recyclé*

- 99981** | H38 Ø50
- 99982** | H41 Ø60
- 99983** | H46 Ø80

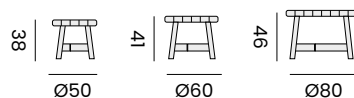

## NOAH

coffee table, recycled teak  
*table basse, teck recyclé*

- 99897** | Ø60
- 99898** | Ø75
- 99899** | Ø92

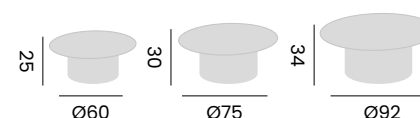





## DJERBA

fabric sunproof, quick dry foam  
*tissu sunproof, mousse séchage rapide*

1-seat - *fauteuil*

**97447** | teak, cushion natural  
*teck, coussin naturel*



2-seat - *canapé 2P*

**97446** | teak, cushion natural  
*teck, coussin naturel*

3-seat - *canapé 3P*

**97445** | teak, cushion natural  
*teck, coussin naturel*



footrest - *repose pied*

**97449** | teak, cushion natural  
*teck, coussin naturel*

coffee table - *table basse*

**97448** | teak, H21 L160 W90  
*teck, H21 L160 W90*

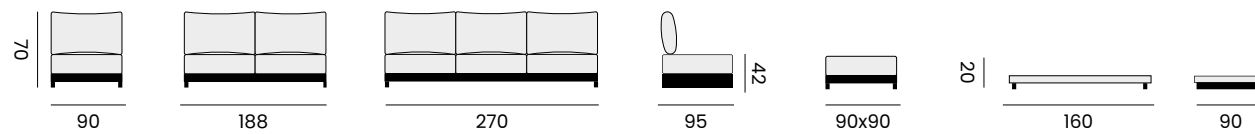



## LECCE

2x 1-seat, 2-seat, coffee table (set 2 pieces),  
cushions fabric sunproof  
*2x fauteuil, canapé 2P, table basse (set 2 pièces),  
coussins tissu sunproof*

lounge set - *ensemble salon*

**97442** | teak, cushion light grey  
*teck, coussin gris claire*

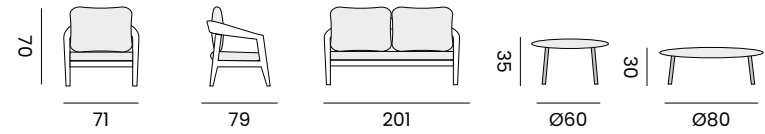

## COMO

2x 1-seat, 2-seat, coffee table (set 2 pieces),  
cushions fabric sunproof  
*2x fauteuil, canapé 2P, table basse (set 2 pièces),  
coussins tissu sunproof*

lounge set - *ensemble salon*

**97443** | teak, cushion light grey  
*teck, coussin gris claire*

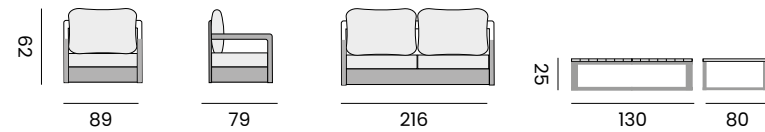

## MENDOZA

fabric sunproof, quick dry foam  
*tissu sunproof, mousse séchage rapide*

1-seat - *fauteuil*

**97162** | alu linnen - rope beige + cushion  
*alu lin - corde beige + coussin*

3-seat - *canapé 3P*

**97163** | alu linnen - rope beige + cushion  
*alu lin - corde beige + coussin*

## DIAZ

coffee table, alu linnen, ceramic top 12mm  
*table basse, alu lin, plateau en ceramique 12mm*

**97164** | Ø50 H

**97165** | Ø90 H

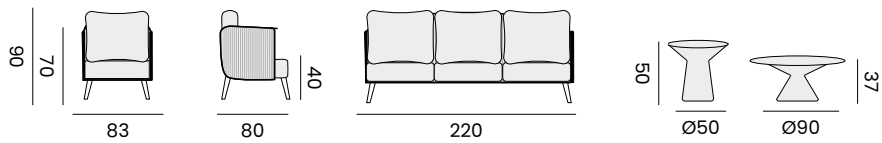



## VIGO

fabric sunbrella, sock 8cm olefin, quick dry foam  
*tissu sunbrella, chaussette 8cm oléfine, mousse séchage rapide*

### 1-seat - *fauteuil*

- 97635** | alu charcoal - sock dark grey  
*alu charcoal - chaussette grise foncée*
- 97774** | alu white - sock light grey  
*alu blanc - chaussette grise claire*

### 2,5-seat - *canapé 2,5P*

- 97636** | alu charcoal - sock dark grey  
*alu charcoal - chaussette grise foncée*
- 97775** | alu white - sock light grey  
*alu blanc - chaussette grise claire*

### coffee table (2 pieces) - *table basse (set 2 pièces)*

- 97628** | alu charcoal - *alu charcoal*
- 97629** | alu white - *alu blanc*

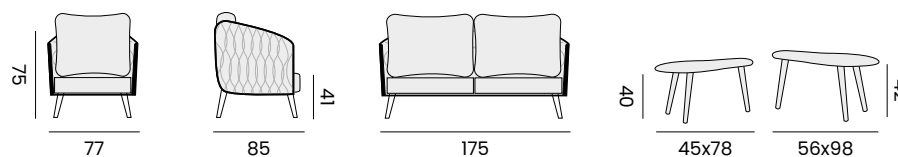





## LAGOS

fabric sunproof, quick dry foam  
*tissu sunproof, mousse séchage rapide*

lounge set with coffee table ceramic top  
*salon avec table basse, plateau en céramique*

**98202** | alu charcoal - cushion/rope dark grey + pillows  
*alu charcoal - coussin/corde grise foncée  
 + coussons décos*



## GABON

fabric + pillows olefin  
tissu+ coussins oléfine

1-seat - *fauteuil*

- 97624** | alu charcoal - cushion/rope dark grey  
*alu charcoal - coussin/corde grise foncée*
- 97625** | alu white - cushion/rope light grey  
*alu blanc - coussin/corde grise claire*

2,5-seat - *canapé 2,5P*

- 97626** | alu charcoal - cushion/rope dark grey  
*alu charcoal - coussin/corde grise foncée*
- 97627** | alu white - cushion/rope light grey  
*alu blanc - coussin/corde grise claire*

coffee table (2 pieces) - *table basse (set 2 pièces)*

- 97628** | alu charcoal - *alu charcoal*
- 97629** | alu white - *alu blanc*

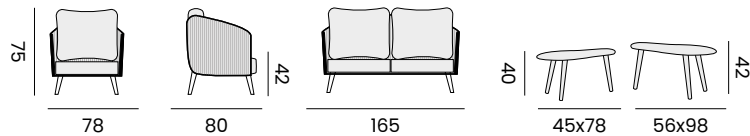

## PARKA

2x 1-seat, 2-seat, fabric olefin  
coffee table ceramic glass top  
*2x fauteuil, canapé 2P, tissu oléfine,  
table basse plateau en verre céramique*

lounge set - *salon*

- 97695** | alu charcoal - cushions/rope dark grey  
*alu charcoal - coussin/corde grise foncée*

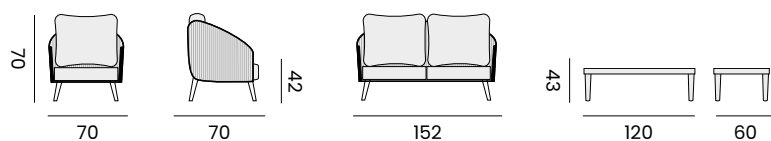





## EDEN

2x 1-seat, 2-seat, coffee table (set 2 pieces)  
cushions, rope olefin  
*2x fauteuil, canapé 2P, table basse (set 2 pièces)*  
*coussins, corde oléfine*

lounge set - *salon*

**97642** alu charcoal - cushion grey/rope dark grey  
*alu charcoal - coussin gris/corde grise foncée*

**97643** alu white - cushion light grey/rope grey  
*alu blanc - coussin grise claire/corde grise*

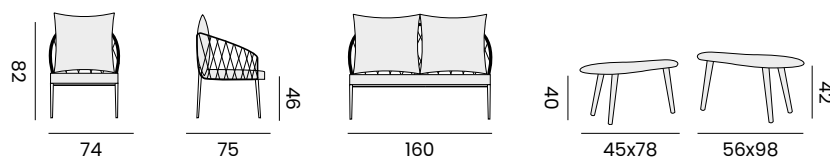

## DIEGO

1-seat - *fauteuil*

- 97768** | alu white - rope olefin light grey  
*alu blanc - corde oléfine grise claire*
- 97753** | alu black - rope black + teak armrest  
*alu noir - corde noir + accoudoirs en teck*

3-seat - *canapé 3P*

- 97769** | alu white - rope olefin light grey  
*alu blanc - corde oléfine grise claire*
- 97754** | alu black - rope black + teak armrest  
*alu noir - corde noir + accoudoirs en teck*

coffee table (2 pieces) - *table basse (set 2 pièces)*

- 97629** | alu white - *alu blanc*
- 97631** | alu black - *alu noir*

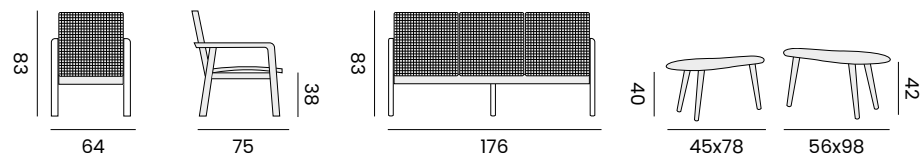

## MARGARITE

round coffee table,  
iron legs black, recycled teak top  
*table basse ronde,  
pieds en acier noir, plateau en teck recyclé*

- 99971** | Ø40 H36
- 99972** | Ø70 H42
- 99973** | Ø100 H47

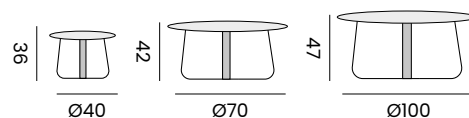



## PALMA

2x 2-seat, 1-seat, corner seat, coffee table ceramic top  
 cushions + small cushions + pillows olefin  
*2x unité 2P, unité 1P, table basse plateau en céramique  
 coussins + petits coussins + coussins déco oléfine*

lounge set - salon

- 97400** alu black - cushions/rope dark grey  
*alu noir - coussin/corde grise foncée*
- 97401** alu white - cushions/rope sand  
*alu blanc - coussin/corde sable*

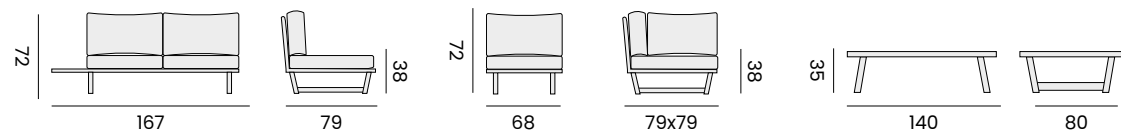



## ELBA

2x 1-seat, 3-seat, coffee table ceramic top  
 cushions + 2 pillows olefin  
*2x fauteuil, canapé 3P, table basse plateau en céramique  
 coussins + 2 coussins décos oléfine*

lounge set - salon

**97405** | alu black - cushions/rope dark grey  
*alu noir - coussin/corde grise foncée*

**97406** | alu white - cushions/rope sand  
*alu blanc - coussin/corde sable*

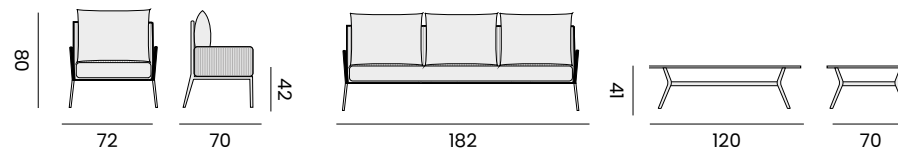

## VINICA

2-seat, 3-seat, corner table, coffee table,  
fabric sunproof + pillows  
*canapé 2P, canapé 3P, table de coin, table basse*  
*tissu sunproof + coussins déco*

lounge set - *salon*

**97390** | alu charcoal/teak - cushions dark grey  
*alu charcoal/teck - coussins gris foncé*

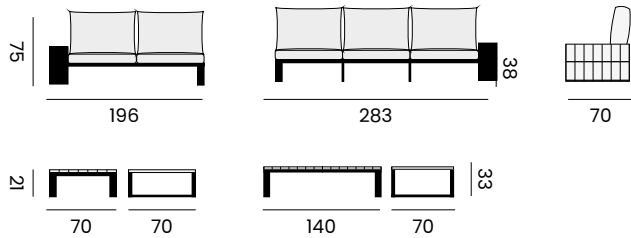

## VALDEZ

3-seat left corner, 3-seat, coffee table,  
fabric sunproof, quick dry foam + pillows  
*canapé 3P coin gauche, canapé 3P, table basse*  
*tissu sunproof, mousse séchage rapide + coussins déco*

lounge set - *salon*

**97440** | alu charcoal/teak - cushions dark grey  
*alu charcoal/teck - coussins gris foncé*

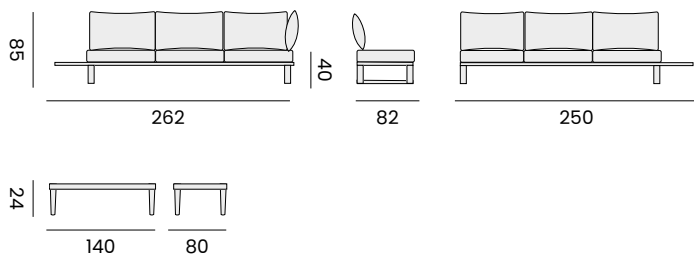

## HAWAI

left & right 2-seat, corner seat  
coffee table, fabric olefin + cushions, pillows  
*canapé 2P gauche et droite, unité de coin  
table basse, tissu oléfine + coussins, coussins déco*

lounge set - *salon*

**97653** | alu charcoal/teak - cushions black  
*alu charcoal/teak - coussins noir*

**97659** | alu white/teak - cushions grey  
*alu blanc/teak - coussins gris*

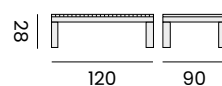
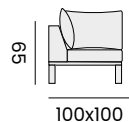
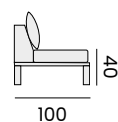
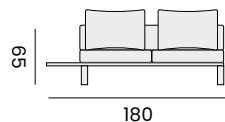

element - *unité 1P*

**97657** | alu charcoal - cushions black  
*alu charcoal - coussins noir*

**97663** | alu white - cushions grey  
*alu blanc - coussins gris*

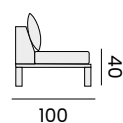
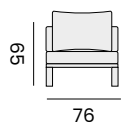



## ALBA

2-seat, longchair  
 coffee table, fabric olefin  
*canapé 2P, chaise longue*  
*table basse, tissu oléfine*

lounge set - *salon*

**97441** alu charcoal - teak,  
 cushion dark grey, rope black  
*alu charcoal - teck,*  
*coussin gris foncé, corde noir*

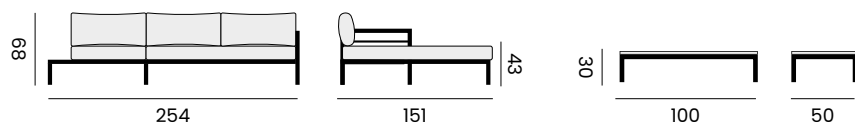



## NATAL

2-seat, longchair  
 coffee table, fabric olefin + 3 pillows  
*canapé 2P, chaise longue*  
*table basse, tissu oléfine + 3 coussins déco*

lounge set - *salon*

**95078** | alu black/teak - cushions dark grey  
*alu noir/teck - coussins gris foncés*

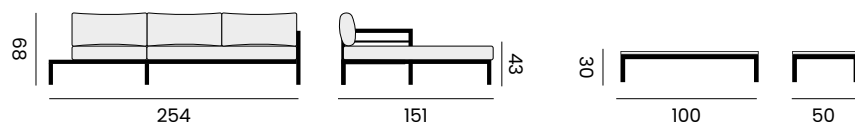





## FUERTE

2x 2-seat, 1-seat element, corner seat, coffee table,  
 fabric oléfin + 6 pillows  
 2x canapé 2P, fauteuil, unité de coin, table basse  
 tissu oléfine + 6 coussins déco

lounge set - salon

**97407** | alu black/teak - cushions dark grey, rope black  
 alu noir/teck - coussins gris foncé, corde noir

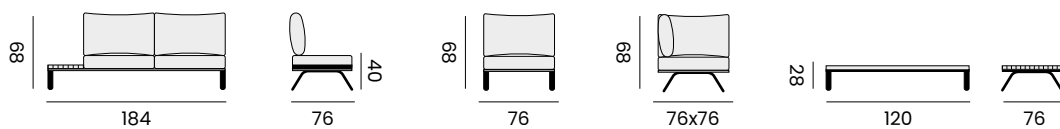



## GADELOUPE

2x 1-seat, 2-seat, coffee table  
 fabric olefin + 4 pillows  
 2x fauteuil, canapé 2P  
 table basse, tissu oléfine + 4 coussins

lounge set - salon

**97650** | alu charcoal/teak - cushions jute  
 alu charcoal/teck - coussins jute

**97674** | alu white/teak - cushions grey  
 alu blanc/teck - coussins gris

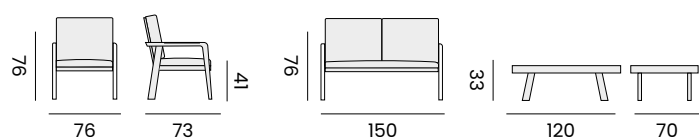

**PILLOW, COUSSIN DÉCO**

sunbrella, 45x45cm

- 71040** Komo rafia
- 71041** Majestic citrine
- 71044** Komo Coua
- 71045** Heritage sky (blue)
- 71010** catania yellow
- 71011** catania orange
- 71012** catania blue
- 71013** catania purple



**PILLOW, COUSSIN DÉCO**

sunbrella, 35x60cm

- 72040** Komo rafia
- 71014** catania yellow
- 71015** catania orange
- 71016** catania blue
- 71017** catania purple

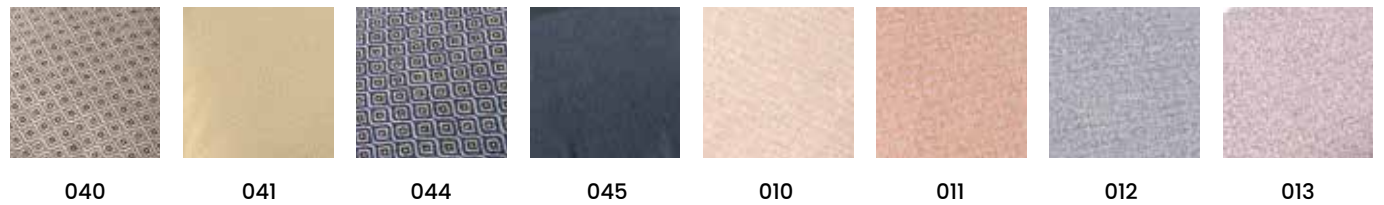

## ROMA

cushionbox  
coffre de coussins

- 97699** | alu charcoal 85x170  
alu charcoal 85x170
- 97698** | XL alu charcoal 110x210  
XL alu charcoal 110x210

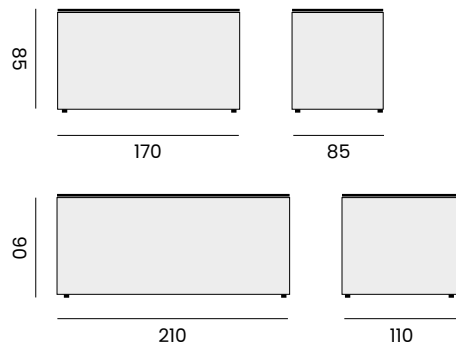

## MILANO

side table, round cord wicker  
table d'appoint, résine tressée ronde

- 97586** | wicker cappuchino, frozen glass top  
résine tressée cappuchino,  
plateau en verre dépoli

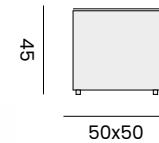

## FIRENZE

side table, round cord wicker  
table d'appoint, résine tressée ronde

- 99520** | wicker natural brushed, frozen glass top  
résine tressée naturelle brossée,  
plateau en verre dépoli
- 99038** | wicker black, frozen glass top  
résine tressée noire,  
plateau en verre dépoli

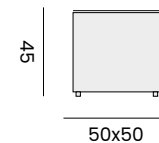

## GABON/VIGO

coffee table (2 pieces)  
table basse (2 pièces)

- 97628** | alu charcoal  
*alu charcoal*
- 97629** | alu white  
*alu blanc*
- 97631** | alu black  
*alu noir*

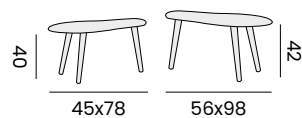

## SORRENTO

side table - *table d'appoint*

- 96093** | alu charcoal  
*alu charcoal*
- 96114** | alu white  
*alu blanc*

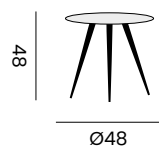

coffee table - *table basse*

- 96086** | alu green  
*alu vert*
- 96040** | alu charcoal  
*alu charcoal*
- 96115** | alu white  
*alu blanc*

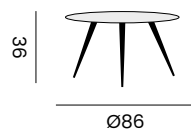

## TENERIFE

side table - *table d'appoint*

- 97413** | alu charcoal  
*alu charcoal*
- 97414** | alu black  
*alu noir*
- 97415** | alu white  
*alu blanc*

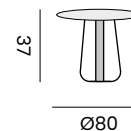

## FIORI

coffee table  
*table basse*

97967 | alu charcoal, ceramic charcoal  
*alu charcoal, céramique charcoal*

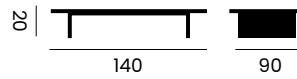

## FIORI/AVENATTI

side table  
*table d'appoint*

97906 | alu white  
*alu blanc*

97913 | alu charcoal  
*alu charcoal*

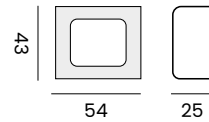

## LAGOS

coffee table (2 pieces)  
*table basse (2 pièces)*

98203 | alu charcoal, ceramic charcoal  
*alu charcoal, céramique charcoal*

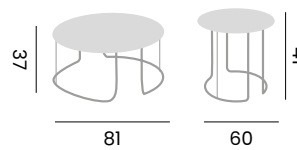



## NOAH

coffee table, recycled teak  
*table basse, teck recyclé*

<b>99897</b>	Ø60
<b>99898</b>	Ø75
<b>99899</b>	Ø92

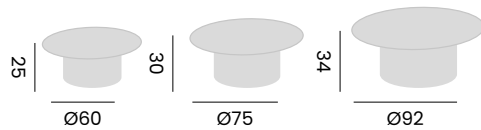

## FERDI

coffee table, recycled teak  
*table basse, teck recyclé*

<b>99981</b>	Ø50 H36
<b>99982</b>	Ø60 H41
<b>99983</b>	Ø80 H48

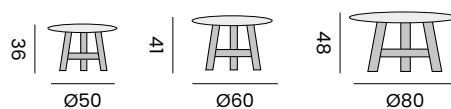

## MEDINA

side table, teak  
*table d'appoint, teck*

<b>97454</b>	Ø70 H50
--------------	---------

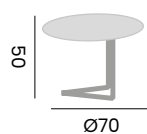

## SANTORINI

coffee table - *table basse*

**97433** | teak, half moon H21 L90 W70  
*teck, demi lune H21 L90 W70*

**97434** | teak, round H21 Ø90  
*teck, ronde H21 Ø90*

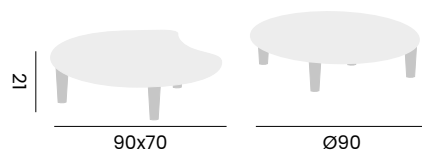

## RIO

round coffee table, teak  
*table basse ronde, teck*

**95080** | Ø35 H32

**95081** | Ø48 H37

**95082** | Ø60 H42

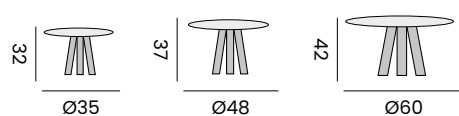

## MARGARITE

round coffee table,  
iron legs, recycled teak top  
*table basse ronde,  
pieds en acier noir, plateau en teck recyclé*

**99971** | Ø40 H36

**99972** | Ø70 H42

**99973** | Ø100 H47

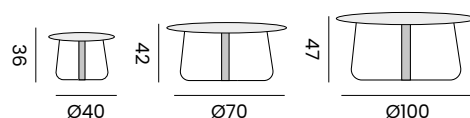



## VIALLI

coffee table,  
teak - top sintered stone  
*table basse,*  
*teck - plateau en pierre frittée*

- 97996** | small H47 Ø42cm
- 97997** | medium H32 Ø80cm
- 97998** | large H28 L140 W90

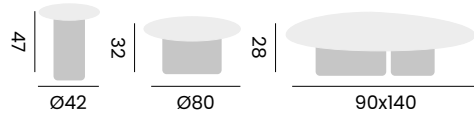

## RAFA

coffee table  
*table basse*

- 97976** | teak, 90x140  
*teck, 90x140*
- 97988** | alu white, ceramic white, 90x140  
*alu blanc, céramique blanc, 90x140*

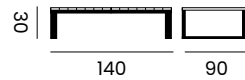

## RAFA

fabric agora, quick dry foam  
*tissu agora, mousse séchage rapide*

1-seat - *fauteuil*

- 97968** | teak - twitell IO + cushions, *teck - twitell IO + coussins*
- 98100** | teak - mario siesta ecru + cushions, *teck - mario siesta écru + coussins*
- 97980** | alu white - bruma niebla + cushions, *alu blanc - bruma niebla + coussins*

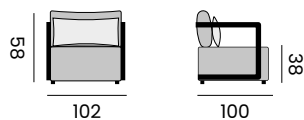

## FIORI

fabric agora, quick dry foam  
*tissu agora, mousse séchage rapide*

1-seat - *fauteuil*

**alu charcoal - senda dragon**

- 97943** | seat element, *unité 1P*
- 97946** | single backrest + striped cushion, *unité dossier 1P + coussin rayé*

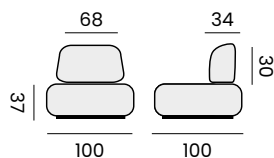

## AVENATTI

fabric agora, quick dry foam  
*tissu agora, mousse séchage rapide*

1-seat - *fauteuil*

**alu white - senda dragon**

- 97900** | seat element, *unité 1P*
- 97902** | backrest + cushion, *unité dossier + coussin*

**alu charcoal - senda sombra**

- 97908** | seat element, *unité 1P*
- 97910** | backrest + cushion, *unité dossier + coussin*

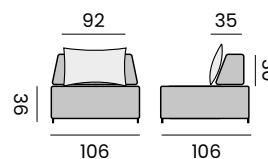



## TOTTI

fabric agora, quick dry foam, swivel  
*tissu agora, mousse séchage rapide, système de rotation*

1-seat - *fauteuil*

**97999** | bruma niebla + 2 cushions + 1 pillow  
*bruma niebla + 2 coussins + 1 coussin déco*

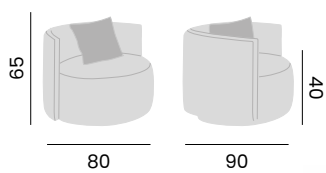

## FESTINI

fabric agora, quick dry foam  
*tissu agora, mousse séchage rapide*

1-seat - *fauteuil*

**97940** | senda dragon

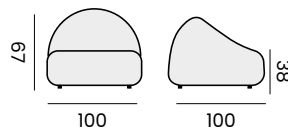

## GABON

fabric + pillows olefin  
*tissu+ coussins oléfine*

1-seat - *fauteuil*

- 97624** | alu charcoal - cushion/rope dark grey  
*alu charcoal - coussin/corde grise foncée*
- 97625** | alu white - cushion/rope light grey  
*alu blanc - coussin/corde grise claire*

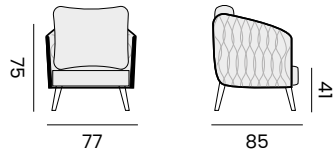

## VIGO

fabric sunbrella, sock 8cm olefin, quick dry foam  
*tissu sunbrella, chaussette 8cm oléfine, mousse séchage rapide*

1-seat - *fauteuil*

- 97635** | alu charcoal - sock dark grey  
*alu charcoal - chaussette grise foncée*
- 97774** | alu white - sock light grey  
*alu blanc - chaussette grise claire*

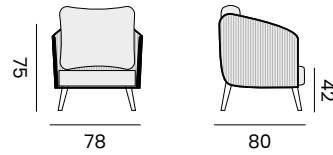

## DIEGO

1-seat - *fauteuil*

- 97768** | alu white - rope olefin light grey  
*alu blanc - corde oléfine grise claire*
- 97753** | alu black - rope black + teak armrest  
*alu noir - corde noir + accoudoirs en teck*

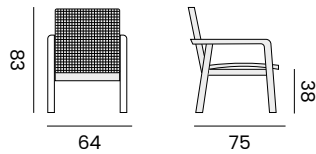

## CASABLANCA

fabric sunbrella, quick dry foam  
*tissu sunbrella, mousse séchage rapide*

1-seat - *fauteuil*

- 99984** | recycled teak, frame only  
*teck recyclé, **seulement la structure***
- 99996** | cushion set heritage leaf  
*set coussins heritage leaf*
- 99997** | cushion set heritage papyrus  
*set coussins heritage papyrus*

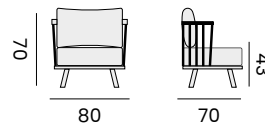





## SEMARANG

dining chair - *fauteuil*

**95054** | teak, *teck*

cushion - *coussin* H4 W55 D60

**95057** | sunbrella heritage papyrus  
*sunbrella heritage papyrus*

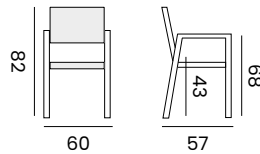

## MENORCA

dining chair - *fauteuil*

**99993** | recycled teak  
viro wicker rope + cushion sunproof ecru  
*teck recyclé, viro corde resine tressée*  
*coussin sunproof écru*

side chair - *chaise*

**99994** | recycled teak  
viro wicker rope + cushion sunproof ecru  
*teck recyclé, viro corde resine tressée*  
*coussin sunproof écru*

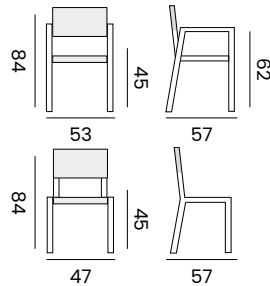



MENORCA

## LUNA

side chair - *chaise*

**97455** teak, wicker rope brown,  
cushion sunproof taupe  
*teck, corde resine tressée marron  
coussin sunproof taupe*

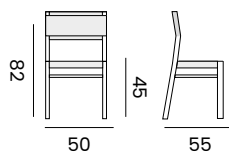

dining chair - *fauteuil*

**97456** teak, wicker rope brown,  
cushion sunproof taupe  
*teck, corde resine tressée marron  
coussin sunproof taupe*

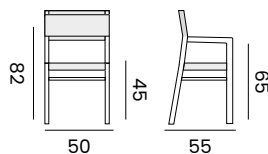

loung chair - *chaise lounge*

**97457** teak, wicker rope brown,  
cushion sunproof taupe  
*teck, corde resine tressée marron  
coussin sunproof taupe*

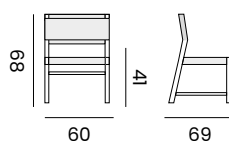





## JAKARTA

dining chair - *fauteuil*

**95052** | teak, *teck brut*

cushion - *coussin* H4 W55 D60

**95053** | sunbrella heritage leaf  
*sunbrella heritage leaf*

**95058** | sunbrella heritage papyrus  
*sunbrella heritage papyrus*

**95059** | sunbrella heritage charcoal  
*sunbrella heritage charcoal*

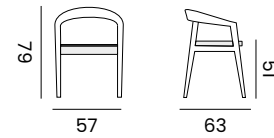

## CABRINI

dining chair - *fauteuil*

**97444** | teak, cushion olefin light grey  
*teck, coussin oléfine gris clair*

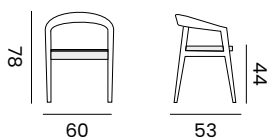

## MARRAKESH

stacking side chair - *chaise empilable*

**97450** | teak grey wash, cushion olefin light grey  
*teck lavage gris, coussin oléfine gris clair*

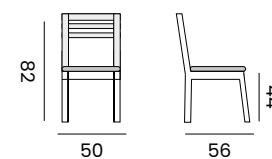

stacking arm chair - *fauteuil empilable*

**97451** | teak grey wash, cushion olefin light grey  
*teck lavage gris, coussin oléfine gris clair*

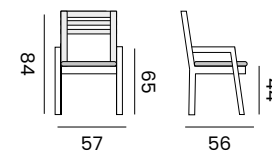

## YORK

folding chair - *chaise pliante*

**99081** | teak, *teck*

folding armchair - *fauteuil pliante*

**99082** | teak, *teck*

stackable armchair - *fauteuil empilable*

**99083** | teak, *teck*

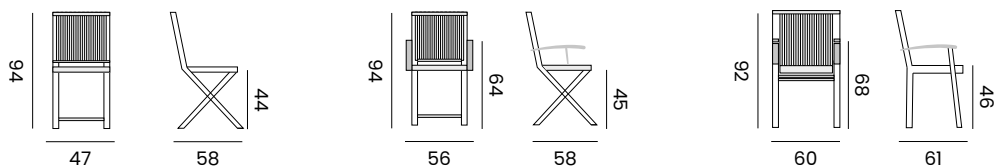

cushion p. 123 - *coussin p. 123*

## LENS

folding chair - *chaise pliante*

**99131** | teak, *teck*

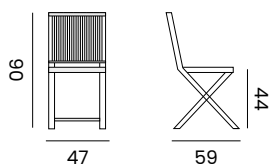

cushion p. 123 - *coussin p. 123*

## HERMOSA

stool - *tabouret*

**99968** | recycled teak  
*teck recyclé*

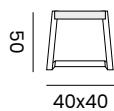



## MENDOZA

dining chair - *chaise*

**97161** | alu linnen, rope beige  
cushion olefin  
*alu lin, corde beige  
coussin oléfine*

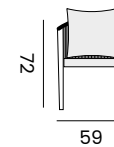

## UNO

dining chair - *fauteuil*

- 97694** | alu white, cushion sunproof grey  
rope olefin light grey  
*alu blanc, coussin sunproof gris  
corde oléfine grise claire*
- 97697** | alu charcoal, cushion olefin dark grey  
rope olefin dark grey  
*alu charcoal, coussin oléfine gris foncé  
corde oléfine grise foncée*

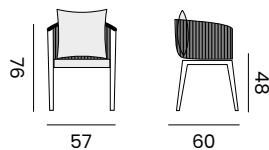

## GABON

dining chair - *fauteuil*

- 97620** | alu charcoal, cushion olefin dark grey,  
rope olefin dark grey  
*alu charcoal, coussin oléfine gris foncé,  
corde oléfine grise foncée*
- 97621** | alu white, cushion olefin light grey  
rope olefin light grey  
*alu blanc, coussin oléfine gris clair  
corde oléfine grise claire*

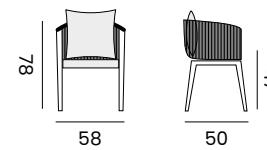



## VIGO

dining chair

sock 8 cm, cushion sunbrella quick dry foam

*fauteuil*

*chaussette 8 cm, coussin sunbrella mousse séchage rapide*

**97637** | alu charcoal, sock olefin dark grey  
*alu charcoal, chaussette oléfine gris foncée*

**97771** | alu white, sock olefin grey  
*alu blanc, chaussette oléfine grise claire*

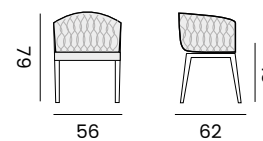



**DIEGO**

stackable armchair - *fauteuil empilable*

**97752** | alu black, rope olefin black,  
teak armrest  
*alu noir, cordes oléfine noires,  
accoudoirs en teck*

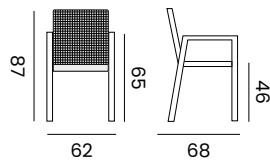



## FORLI

stackable side chair - *chaise empilable*

- 96192** | stainless steel black, rope dark grey  
*acier inoxydable noir, corde grise foncée*
- 96193** | stainless steel white, rope light grey  
*acier inoxydable blanc, corde grise claires*

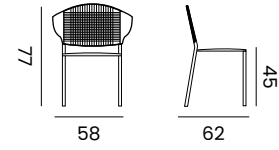





## ARUBA

stackable armchair - *fauteuil empilable*

**97573** | alu charcoal, rope textylène black  
*alu charcoal, cordes textilènes noires*

**97575** | alu black, rope textylène black,  
teak armrest  
*alu noir, cordes textilènes noires,  
accoudoirs en teck*

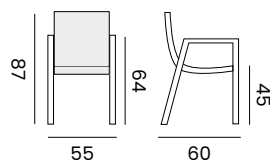

## GENÈVE

stackable dining chair - *fauteuil empilable*

**98023** | alu charcoal, rope black, textylène silver grey  
*alu charcoal, corde noire, textylène gris argent*

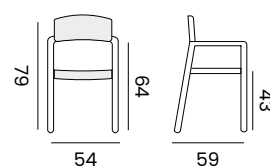



## PIRLO

dining chair - *chaise*

**97385** alu black, rope olefin black  
cushion agora twitell  
*alu noir, corde oléfine noire  
coussin agora twitell*

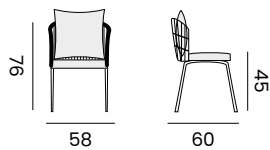

## EDEN

dining chair - *fauteuil*

**97640** alu charcoal, rope olefin grey,  
cushion olefin grey  
*alu charcoal, corde oléfine grise,  
coussin oléfine gris*

**97641** alu white, rope olefin light grey,  
cushion olefin light grey  
*alu blanc, corde oléfine grise claire,  
coussin oléfine gris claire*

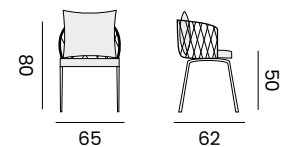



## ANTIBES

dining chair - *fauteuil*

**97652** | alu charcoal, cushion olefin jute,  
teak armrest  
*alu charcoal, coussin oléfine jute,  
accoudoirs en teck*

**97670** | alu white, cushion olefin grey,  
teak armrest  
*alu blanc, coussin oléfine gris,  
accoudoirs en teck*

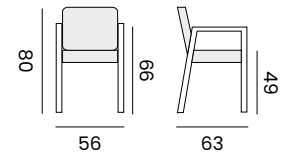

## BILBAO

stackable armchair - *fauteuil empilable*

**95074** | alu white, textylène light grey  
teak armrest  
*alu blanc, textylène noir  
accoudoirs en teck*

**95075** | alu black, textylène light grey  
teak armrest  
*alu noir, textylène noir  
accoudoirs en teck*

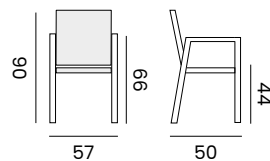



## LISBOA

stackable armchair - *fauteuil empilable*

**98201** | alu charcoal, textylène dark grey  
**teak armrest**  
*alu charcoal, textilène gris foncé*  
*accoudoirs en teck*

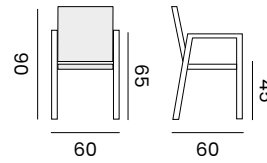



## CHILI

stackable padded armchair  
 inserted cushion quick dry foam  
*fauteuil empilable rembourré  
 mousse séchage rapide*

- 96182** | alu charcoal, textylène antracite  
*alu charcoal, textylène antracite*
- 96183** | alu white, textylène white/sand  
*alu blanc, textylène blanc/sable*
- 97157** | alu linnen, textylène beige  
*alu lin, textylène beige*

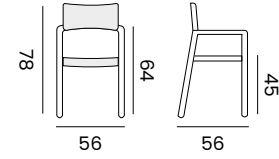

## CAPRI

stackable armchair  
*fauteuil empilable*

**97692** | alu charcoal, padded textylène black  
*alu charcoal, textilène noir matelassé*

**97693** | alu taupe, padded textylène taupe  
*alu taupe, textilène taupe matelassé*

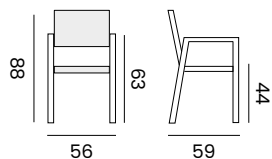

## NICE

stackable side chair  
*chaise empilable*

**96042** | alu white, padded textylène light grey  
*alu blanc, textilène gris clair matelassé*

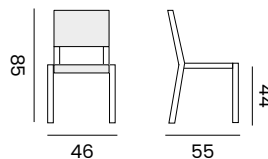

## CASSIS

folding chair - *chaise pliante*

**97719** | alu white, textylène light grey  
*alu blanc, textilène gris clair*

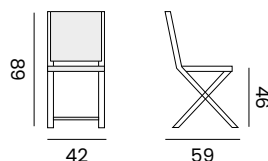

## JAVEA

folding armchair - *fauteuil pliant*

**97512** | alu white, textylène light grey  
*alu blanc, textilène gris clair*

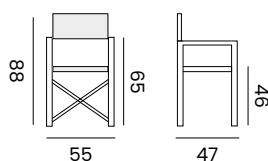

## RONDA

stackable armchair - *fauteuil empilable*

- 97598** | alu black, textylène black  
*alu noir, textilène noir*
- 97604** | alu charcoal, textylène light grey  
*alu charcoal, textilène gris clair*
- 97605** | alu white, textylène light grey  
*alu blanc, textilène gris clair*

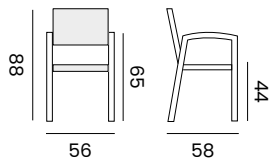

## PEDRO

stackable armchair - *fauteuil empilable*

- 97597** | alu black, textylène black  
*alu noir, textilène noir*
- 97599** | alu white, textylène light grey  
*alu blanc, textilène gris clair*

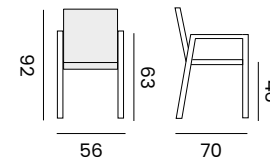

## BARI

stackable armchair - *fauteuil empilable*

- 97256** | alu white, textylène light grey  
*alu blanc, textilène gris clair*
- 97293** | alu charcoal, textylène silver grey  
*alu charcoal, textilène gris argent*
- 97253** | alu champagne, textylène light taupe  
*alu champagne, textilène taupe clair*

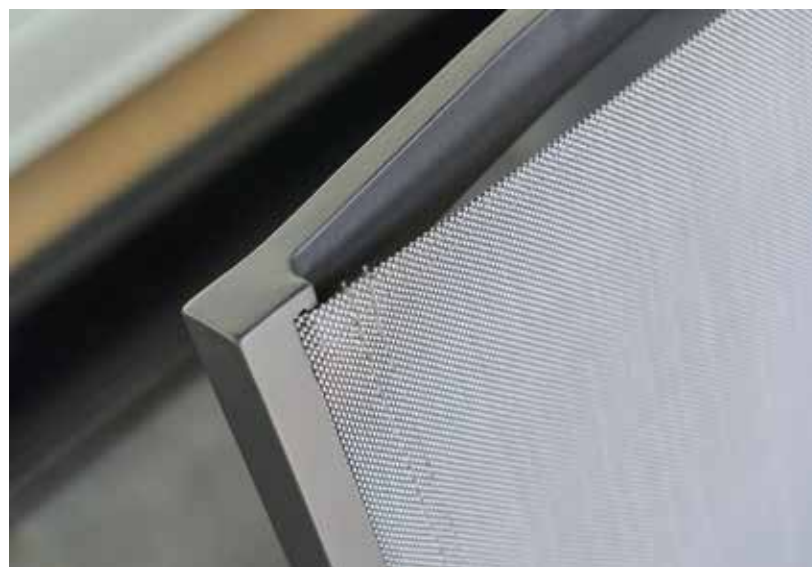
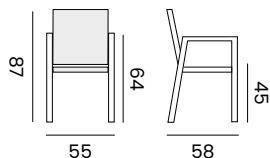

## MALTA

stackable side chair  
*chaise empilable ergonomique*

**96184** | alu white, *alu blanc*

**96185** | alu charcoal, *alu charcoal*

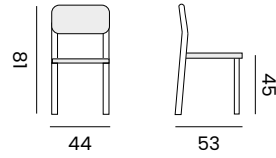

stackable armchair  
*fauteuil empilable ergonomique*

**96186** | alu white, *alu blanc*

**96187** | alu charcoal, *alu charcoal*

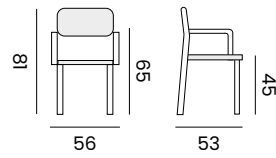

## PARIS

stackable armchair - *fauteuil empilable*

**97211** | alu lime green  
*alu vert lime*

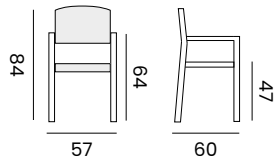

## BASTIA

flat wicker, stackable armchair  
*résine tressée plate, fauteuil empilable*

**97218** | wicker antracite  
*résine tressée antracite*

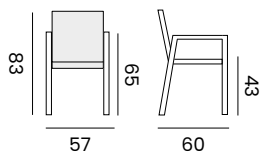







## DUNDEE

rectangular table - *table rectangulaire*

**99959** | recycled teak 100x250  
*teck recyclé 100x250*

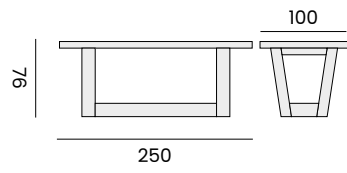

## HERMOSA

rectangular table - *table rectangulaire*

**99966** | recycled teak 100x300  
*teck recyclé 100x300*

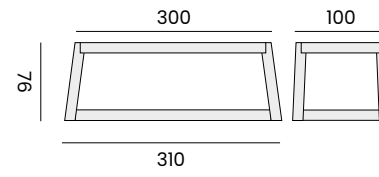

## COTTAGE

rectangular table - *table rectangulaire*

**99573** | recycled teak 120x300  
*teck recyclé 120x300*

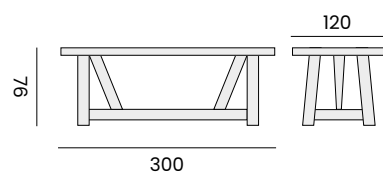

## PRIMITIVE

rectangular table - *table rectangulaire*

**99455** | recycled teak 90x180  
*teck recyclé 90x180*

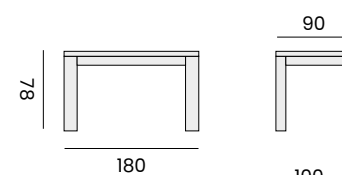

rectangular table - *table rectangulaire*

**99444** | recycled teak 100x250  
*teck recyclé 100x250*

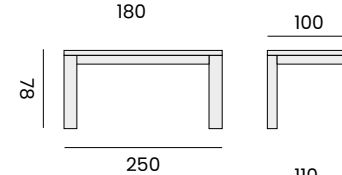

rectangular table - *table rectangulaire*

**99445** | recycled teak 110x300  
*teck recyclé 110x300*

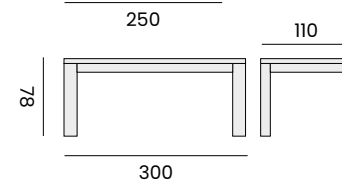

## What is recycled teak wood? *Qu'est-ce que le teck recyclé ?*

One of the most popular materials of the gescova collection is recycled teak. As we become more aware of sustainable materials and seek products which exude a genuine warmth and individuality, recycled teak ticks all of the boxes.

The goal is to provide the highest quality recycled teak hardwood without causing any damage to the environment. We properly utilize 100% reclaimed teak, salvaged from Indonesia, in a zero-waste facility. This means no trees are cut down as a result of our work. Instead, the wood is saved from structures that would have otherwise been demolished and discarded. This rare wood is then refined without any VOC or leeching glues, and delivered to you with hard work, integrity and a passion for the environment.

*Le teck recyclé est l'un des matériaux les plus prisés de la collection Gescova. Alors que nous sommes de plus en plus sensibles aux matériaux durables et que nous recherchons des produits qui émanent une chaleur et une authenticité, le teck recyclé répond à toutes les attentes.*

*Notre objectif est de fournir du teck recyclé de la plus haute qualité sans porter préjudice à l'environnement. Nous utilisons à 100% du teck recyclé, récupéré en Indonésie, dans une usine zéro déchet. Cela signifie qu'aucun arbre n'est abattu dans le cadre de notre travail. Au contraire, le bois est récupéré sur des structures qui auraient autrement été démolies et jetées. Ce bois rare est ensuite affiné sans produits chimiques (COV) ni colle à base de sang, puis livré après un gros travail, avec respect et passion pour l'environnement.*



It starts with old growth wood that was harvested 200-300 years ago to build homes in Indonesia. As the years pass, the teak wood on the facade of the homes collects a patina that only intense sun and moisture can create. In the past decade, many of the neighborhoods throughout the Island nation of Indonesia have been razed to make way for newer and more modern buildings.

Instead of letting this gorgeous old growth teak go to waste, we purchase it before it can be destroyed. From these stacks of wood, we hand sort, hand sand and create some of the worlds finest, unique recycled teak products.

*Il s'agit initialement de bois ancien, récolté il y a 200 à 300 ans pour la construction de maisons en Indonésie. Au fil des ans, le bois de teck des façades des maisons développe une patine que seul le soleil intense et l'humidité peuvent créer. Au cours de la dernière décennie, de nombreux quartiers des îles indonésiennes ont été rasés pour faire place à des bâtiments plus modernes.*

*Plutôt que de laisser ce magnifique teck ancien se perdre, nous l'achetons avant qu'il ne soit détruit. À partir de ces piles de bois, nous trions et ponçons à la main pour créer certains des produits en teck recyclé les plus fins et les plus uniques au monde.*



We know teak is strong and aesthetically beautiful, but it's also naturally resilient to water, termites and rot and is relatively low maintenance. This makes it a perfect material for outside furniture. Its aesthetic qualities as a recycled product are unique too - as each piece has a different history, no two pieces will be the same.

*Nous savons que le teck est robuste et esthétiquement beau, mais il est également naturellement résistant à l'eau, aux termites et à la pourriture, nécessitant relativement peu d'entretien. C'est donc un matériau idéal pour les meubles d'extérieur. Ses qualités esthétiques en tant que produit recyclé sont également uniques - chaque pièce ayant une histoire différente, il n'y a pas deux pièces identiques.*

### Maintenance tips recycled teak:

#### Conseils d'entretien du teck recyclé :

- Teak wood is naturally resistant to stains and water, so no need to worry too much about the spilled wine.  
*Le bois de teck est naturellement résistant aux taches et à l'eau, donc pas besoin de s'inquiéter des déversements de vin.*
- If a spill does occur, wipe it up with a dampened cloth. This will ensure that the cells in the wood absorb some of the water, protecting against cracking.  
*En cas de déversement de vin, essuyez-le avec un chiffon humide. Cela permettra aux cellules du bois d'absorber une partie de l'eau, évitant ainsi les fissures.*
- To disinfect the furniture, use warm, soapy water. Using products with harsher chemicals will wear down the finish.  
*Pour désinfecter le meuble, utilisez de l'eau tiède et savonneuse. L'utilisation de produits contenant des substances chimiques agressives risque d'endommager la finition.*
- Wood is a living product that moves with time and shrink and expand under influence of humidity and temperature changes. This can cause cracks and fissures in the wood. However, this process does not shorten the life of the teak. It is therefore nothing to worry about. This is precisely what makes the material so unique.  
*Le bois est un matériau vivant qui évolue avec le temps, se contractant et se dilatant sous l'influence de l'humidité et des changements de température. Cela peut entraîner des fissures et des craquelures dans le bois, mais cela n'affecte pas la durée de vie du teck. Il n'y a donc pas lieu de s'inquiéter, car c'est précisément ce qui rend ce matériau si unique.*





## IBIZA

rectangular table - *table rectangulaire*

**99992** | recycled teak 100x250  
*teck recyclé 100x250*

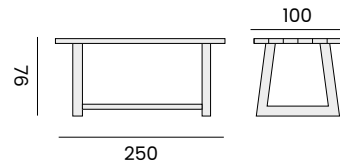

rectangular table - *table rectangulaire*

**99995** | recycled teak 110x300  
*teck recyclé 110x300*

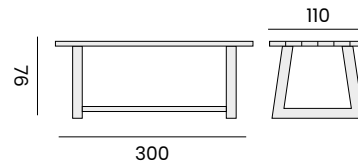

## PRESTON

square coffee table  
*table d'appoint carrée*

**99084** | teak 50x50  
*teck 50x50*

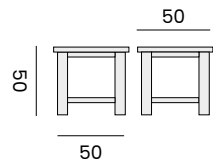

## BLACKBURN

square folding coffee table  
*table d'appoint carrée pliante*

**99090** | teak 70x70  
*teck 70x70*

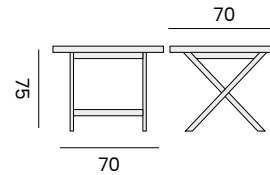

## NORWICH

square table - *table carrée*

**99087** | teak 80x80  
*teck 80x80*

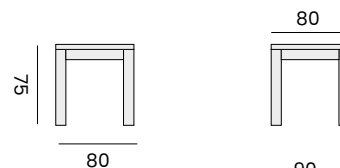

rectangular table - *table rectangulaire*

**99088** | teak 90x160  
*teck 90x160*

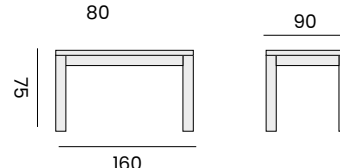

rectangular table - *table rectangulaire*

**99089** | teak 100x220  
*teck 100x220*

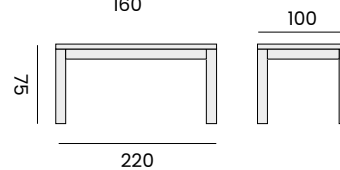



## JAVA

round table - *table ronde*

**95051** | teak Ø135  
teck Ø135

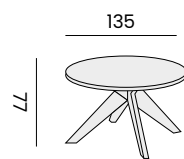

round table - *table ronde*

**95056** | teak Ø165  
teck Ø165

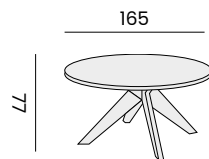

## TUNIS

rectangular table - *table rectangulaire*

**97452** | teak 90x210  
teck 90x210

rectangular table - *table rectangulaire*

**97453** | teak 105x290  
teck 105x290

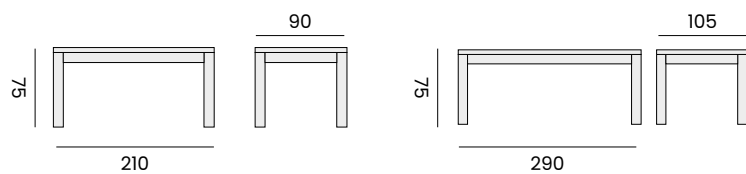



## MYKONOS

rectangular table - *table rectangulaire*

97435 | teak 115x280  
teck 115x280

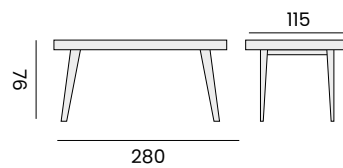



## MARGARITE

black iron frame, recycled teak top  
*armature acier noir, plateau teck recyclé*

rectangular table - *table rectangulaire*

**99970** | 110x300  
**99986** | 110x250

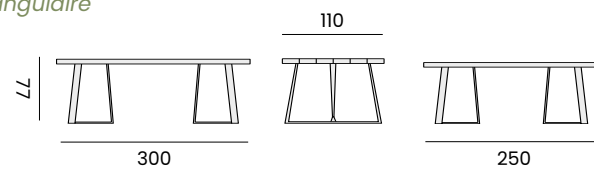

square table - *table carrée*

**99978** | 150x150  
**99979** | 80x80

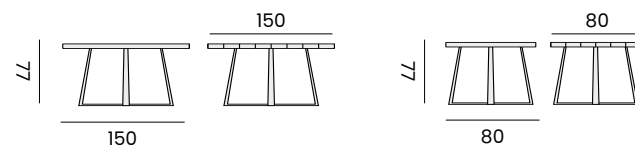

round table - *table ronde*

**99980** | Ø 90  
**99969** | Ø 130  
**99965** | Ø 160

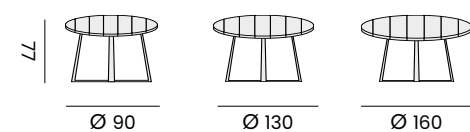

## LUCIE

iron frame, recycled teak top  
*armature acier, plateau teck recyclé*

bistro square table  
*table bistro carré*

99750 | 80x80

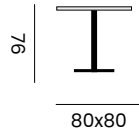

## ROSIE

iron frame, recycled teak top  
*armature acier, plateau teck recyclé*

bistro round table  
*table bistro ronde*

99751 | Ø 100

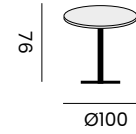



## FANNY

iron frame, recycled teak top  
*armature acier, plateau teck recyclé*

rectangular table - *table rectangulaire*

99896 | 115x300

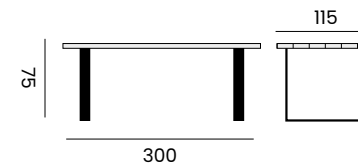



## ROSSI

rectangular table - *table rectangulaire*

**98120** | legs alu charcoal, teak top, 120x320  
*pieds en alu charcoal, plateau en teck, 120x320*

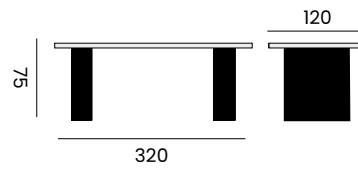



## PORTO

rectangular extendable table  
*table extensible rectangulaire*

**98200** | alu charcoal, teak top, 100x220<->340  
 alu charcoal, plateau en teck, 100x220<->340

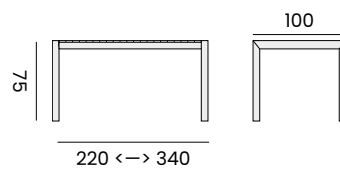



## FELINE

round table - *table ronde*

**97427** | alu charcoal, teak top, Ø 150  
*alu charcoal, plateau en teck, Ø 150*

**97428** | alu charcoal, teak top, Ø 180  
*alu charcoal, plateau en teck, Ø 180*

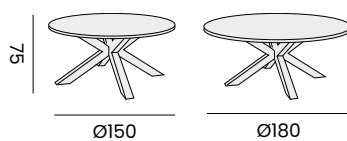

## MARCELO

rectangular table - *table rectangulaire*

**97422** | alu charcoal, teak top, 100x220  
*alu charcoal, plateau en teck, 100x220*

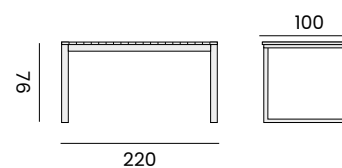

## TREE TRUNK TABLE

rectangular table - *table rectangulaire*

**95055** | alu charcoal, teak top, 100x240  
*alu charcoal, plateau en teck, 100x240*

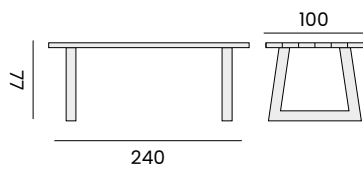

## BRAGA

rectangular table - *table rectangulaire*

**95076** | alu black, teak top, 100x202  
*alu noir, plateau en teck, 100x202*

**95079** | alu white, teak top, 100x202  
*alu blanc, plateau en teck, 100x202*

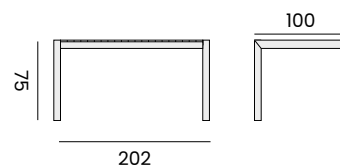

## CORSICA

rectangular table - *table rectangulaire*

- 97651** | alu charcoal, teak top, 90x220  
*alu charcoal, plateau en teck, 90x220*
- 97671** | alu white, teak top, 90x220  
*alu blanc, plateau en teck, 90x220*

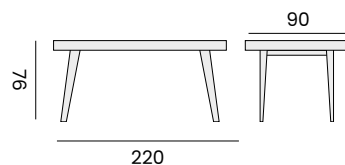

## CARELLI

rectangular picnic table  
*table rectangulaire pique-nique*

- 97392** | alu charcoal, new teak top, 100x220  
*alu charcoal, plateau en teck nouveau, 100x220*
- 97394** | alu white, new teak top, 100x220  
*alu blanc, plateau en teck nouveau, 100x220*
- 97393** | alu charcoal, new teak top, 100x280  
*alu charcoal, plateau en teck nouveau, 100x280*
- 97395** | alu white, new teak top, 100x280  
*alu blanc, plateau en teck nouveau, 100x280*

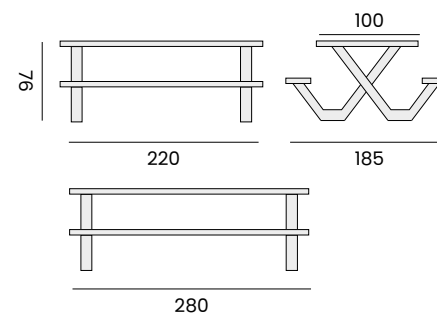

## BONUCCI

rectangular picnic table  
*table rectangulaire pique-nique*

- 97278** | alu white, 110x220  
*alu blanc, 110x220*

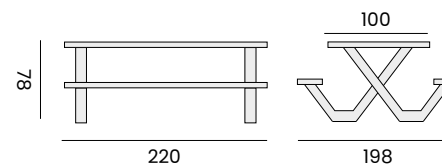

## RIGA

rectangular table - *table rectangulaire*

**97430** | galvanized steel charcoal, teak top, 110x250  
*acier galvanisé charcoal, plateau en teck, 110x250*

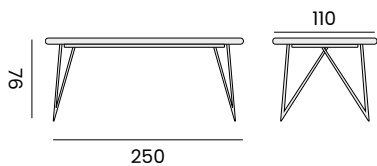

## GRASSE

square folding table  
*table pliante carrée*

**97720** | alu charcoal, 70x70  
*alu charcoal, 70x70*

**97722** | alu white, 70x70  
*alu blanc, 70x70*

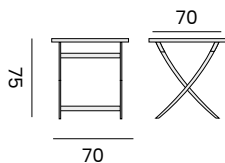

## PRADA

square folding table  
*table pliante carrée*

**94024** | alu white, 70x70  
*alu blanc, 70x70*

**94026** | alu charcoal, 70x70  
*alu charcoal, 70x70*

**94054** | alu black, 70x70  
*alu noir, 70x70*

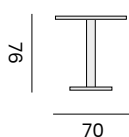

## SALVADOR

square folding table  
*table pliante carrée*

**96189** | alu white, ceramic light grey 80x80  
*alu blanc, céramique gris clair 80x80*

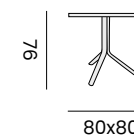

round folding table  
*table pliante ronde*

**96190** | alu charcoal, ceramic antracite Ø80  
*alu charcoal, céramique antracite Ø80*

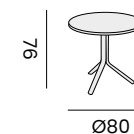

## BETTINI

manual rectangular extendable table  
*table extensible rectangulaire manuelle*

- 96116** | alu charcoal, ceramic antracite, 90x180 <-> 240  
*alu charcoal, plateau en céramique antracite, 90x180 <-> 240*
- 96127** | alu white, ceramic mixed white, 90x180 <-> 240  
*alu blanc, plateau en céramique blanc mixé, 90x180 <-> 240*
- 97158** | alu linnen, ceramic romano travertino, 90x180 <-> 240  
*alu lin, plateau en céramique romano travertino, 90x180 <-> 240*
  
- 96126** | alu charcoal, ceramic antracite, 100x220 <-> 280  
*alu charcoal, plateau en céramique antracite, 100x220 <-> 280*
- 96128** | alu white, ceramic mixed white, 100x220 <-> 280  
*alu blanc, plateau en céramique blanc mixé, 100x220 <-> 280*
- 97159** | alu linnen, ceramic romano travertino, 100x220 <-> 280  
*alu lin, plateau en céramique romano travertino, 100x220 <-> 280*

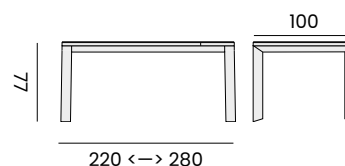
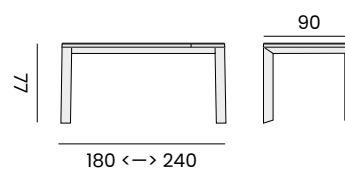

extra extension for table 100x220  
*extra extension pour table 100x220*

- 97153** | alu charcoal, ceramic antracite, 100x60  
*alu charcoal, plateau en céramique antracite, 100x60*
- 97154** | alu white, ceramic mixed white, 100x60  
*alu blanc, plateau en céramique blanc mixé, 100x60*
- 97160** | alu linnen, ceramic romano travertino, 100x60  
*alu lin, plateau en céramique romano travertino, 100x60*





## ROMERO

table, table

- 97166** | alu linnen, ceramic top romano travertino white 12mm, 150x150  
*alu lin, plateau en céramique romano travertino white 12mm, 150x150*
- 97167** | alu linnen, ceramic top romano travertino white 12mm, 110x260  
*alu lin, plateau en céramique romano travertino white 12mm, 110x260*

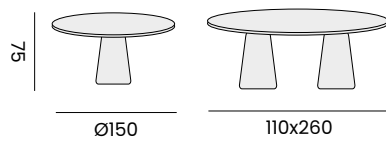



## COPPI

automatic rectangular extendable table,  
*table extensible rectangulaire automatique*

**97755** | alu charcoal, ceramic dark grey, 90x160 ↔ 210  
*alu charcoal, plateau en céramique gris foncé, 90x160 ↔ 210*

**97757** | alu white, ceramic white, 90x160 ↔ 210  
*alu blanc, plateau en céramique blanc, 90x160 ↔ 210*

**97756** | alu charcoal, ceramic dark grey, 100x220 ↔ 280  
*alu charcoal, plateau en céramique gris foncé, 100x220 ↔ 280*

**97758** | alu white, ceramic white, 100x220 ↔ 280  
*alu blanc, plateau en céramique blanc, 100x220 ↔ 280*

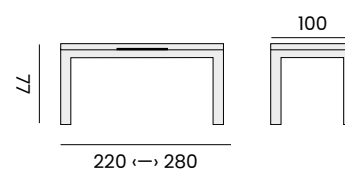
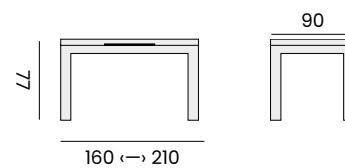







## MALI

rectangular table,  
*table rectangulaire*

- 96180** | alu charcoal, ceramic top black, 120x260  
*alu charcoal, plateau en céramique noir, 120x260*
- 96181** | alu white, ceramic top white, 120x260  
*alu blanc, plateau en céramique blanc, 120x260*

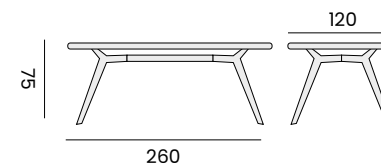

## LIPPI

manual rectangular extendable table,  
*table extensible rectangulaire manuelle,*

- 97952** | alu black, ceramic glass dark grey, 100x180 <-> 270  
*alu noir, plateau en céramique verre gris foncé, 100x180 <-> 270*
- 97953** | alu white, ceramic glass light grey, 100x180 <-> 270  
*alu blanc, plateau en céramique verre gris clair, 100x180 <-> 270*

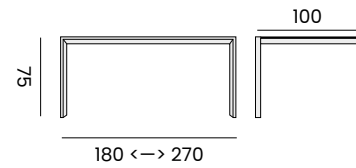

- 97954** | alu white, ceramic glass light grey, 100x240 <-> 360  
*alu blanc, plateau en céramique verre gris clair, 100x240 <-> 360*

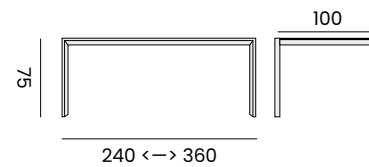

## BASEL

square table,  
*table carrée*

- 98020** | alu charcoal, HPL top, 90x90  
*alu charcoal, plateau en HPL, 90x90*

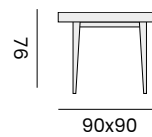

rectangular table,  
*table rectangulaire*

- 98021** | alu charcoal, HPL top, 100x200  
*alu charcoal, plateau en HPL, 100x200*

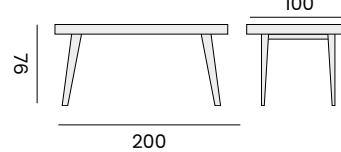

## HELSINKI

rectangular table,  
*table rectangulaire*

- 95036** | teak, Duranite® top white, 100x213  
*teck, plateau en Duranite® blanc, 100x213*

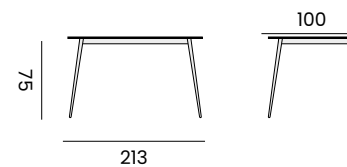



## VIGO

bar chair  
 sock 8 cm, cushion sunbrella quick dry foam  
*chaise de bar*  
*chaussette 8 cm, coussin sunbrella mousse séchage rapide*

- 97772** | alu charcoal - sock olefin dark grey  
 alu charcoal - chaussette oléfine gris foncée
- 97773** | alu white - sock olefin light grey  
 alu blanc - chaussette oléfine grise claire

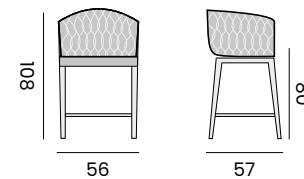

## GABON

bar chair  
 sock 8 cm, fabric olefin, quick dry foam  
*chaise de bar*  
*chaussette 8 cm, tissu oléfine, mousse séchage rapide*

- 97622** | alu charcoal - rope olefin dark grey  
 alu charcoal - corde oléfine gris foncée
- 97623** | alu white - rope olefin light grey  
 alu blanc - corde oléfine grise claire

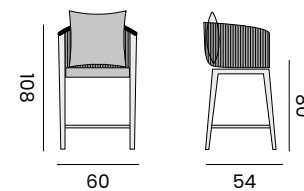

## MATTEO

bar chair - *chaise de bar*

- 96150** | alu white - textylène light grey  
*alu blanc - textilène gris clair*
- 96151** | alu charcoal - textylène silver grey  
*alu charcoal - textilène gris argent*

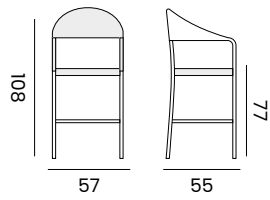

## GENÈVE

bar chair - *chaise de bar*

- 98024** | alu charcoal - rope textylène charcoal  
*alu charcoal - corde textilène charcoal*

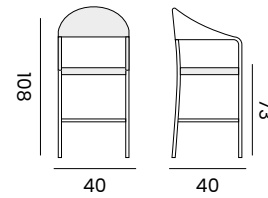

## PONIENTE

bar chair - *chaise de bar*

- 94056** | alu charcoal - textylène silver grey  
*alu charcoal - textilène gris argent*
- 94057** | alu white - textylène light grey  
*alu blanc - textilène gris clair*

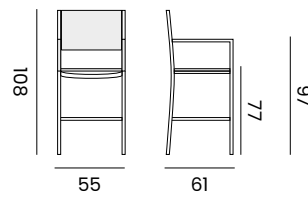

## HERMOSA

rectangular half high bar table  
*table mange-debout rectangulaire*

**99990** | recycled teak 90x180  
*teck recyclé 90x180*

bar stool - *tabouret de bar*

**99991** | recycled teak  
*teck recyclé*

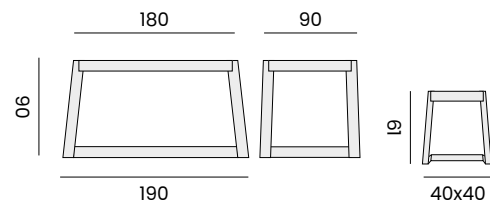

## BRISTOL

trolley, 1 drawer, 1 tray  
*chariot, 1 tiroir, 1 tablette*

**99128** | teak 90x105  
*teck 90x105*

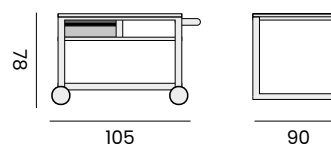

## LUTON

tray, *plateau*

**99132** | teak 5x55x36  
*teck 5x55x36*





## PRADA

square folding bar table  
*table de bar carrée pliante*

- 94050** | alu white 70x70  
*alu blanc 70x70*
- 94051** | alu charcoal 70x70  
*alu charcoal 70x70*

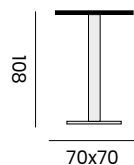

## LUCA

rectangular bar table  
*table de bar rectangulaire*

- 96152** | alu white, ceramic glass light grey 80x150  
*alu blanc, plateau en ceramique verre grise claire, 80x150*

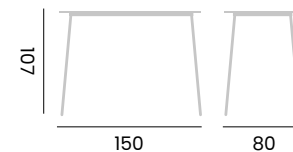

square bar table  
*table de bar carrée*

- 96154** | alu white, ceramic glass light grey 80x80  
*alu blanc, plateau en ceramique verre grise claire, 80x80*

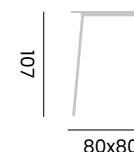

## ZURICH

square bar table  
*table de bar carrée*

- 98022** | alu charcoal, top HPL 90x90  
*alu charcoal, plateau en HPL 90x90*

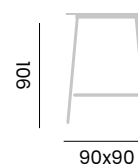



## HERMOSA

bench - *banc*

**99967** | recycled teak, 300cm  
teck recyclé, 300cm

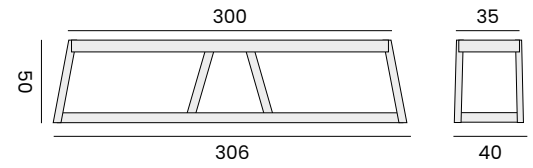

## DUNDEE

bench - *banc*

**99960** | recycled teak, 250cm  
teck recyclé, 250cm

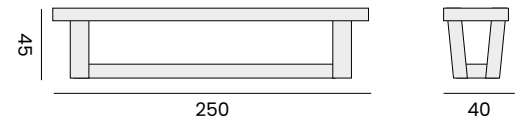

## COTTAGE

bench - *banc*

**99574** | recycled teak, 300cm  
teck recyclé, 300cm

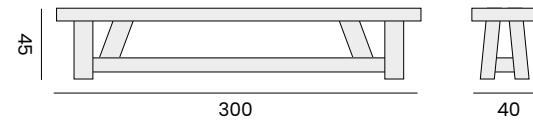





## YORK

bench - *banc*

- 99085** | teak 150cm (cushion p. 123)  
teck 150cm (coussin p. 123)
- 99086** | teak 180cm (cushion p. 123)  
teck 180cm (coussin p. 123)

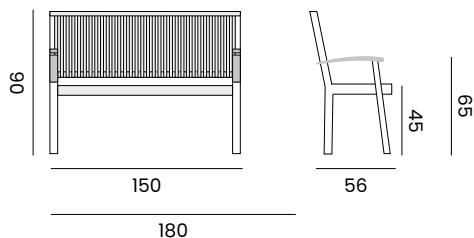

## LEON

bench - *banc*

- 99895** | recycled teak 160cm  
teck recyclé 160cm

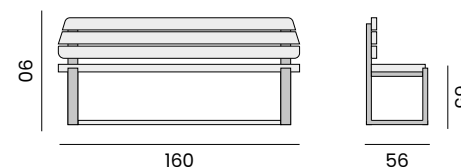

## MARCELO

bench - *banc*

- 97423** | alu charcoal, teak seat 195cm  
alu charcoal, assise en teck 195cm

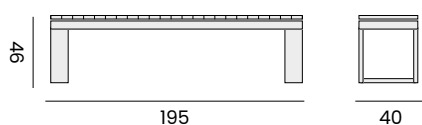

## MARGARITE

bench - *banc*

- 99987** | iron frame black, recycled teak seat, 250cm  
armature acier noir, assise en teck recyclé 250cm
- 99988** | iron frame black, recycled teak seat, 300cm  
armature acier noir, assise en teck recyclé 300cm

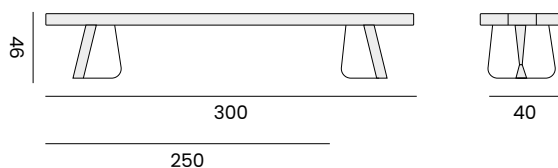







## JUAN

sunlounger - lit bain de soleil

**97978** | teak, cushion twitell IO  
teck, coussin twitell IO

**97979** | teak, cushion mario siesta  
teck, coussin mario siesta

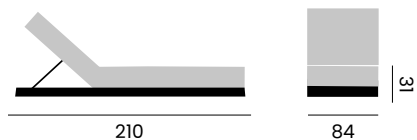

## KOS

sunlounger, fabric sunproof + protection cover  
lit bain de soleil, tissu sunproof + housse de protection

**97436** | teak, cushion ecru,  
2x pillow green & ecru  
teck, coussin écru,  
2x cousin déco écru & vert

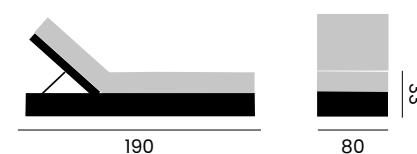

## BALI

sunlounger, cushion stinson  
*lit bain de soleil, coussin stinson*

95050 | teak, cushion ecru,  
teck, coussin écreu,

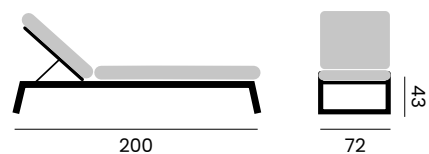

## BELFAST

steamer  
*chaise longue*

99111 | teak (cushion p. 123)  
teck (coussin p. 123)

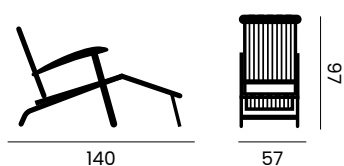

## OXFORD

sunlounger, 2 parts with tray  
*lit bain de soleil, 2 pièces avec tablette*

99127 | teak (cushion p. 123)  
teck (coussin p. 123)

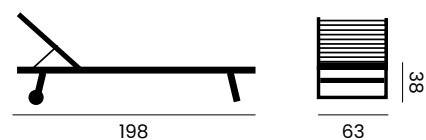



## TRENTI

sunlounger, fabric agora  
*lit bain de soleil, tissu agora*

**97977** | alu charcoal, senda dragon  
*alu charcoal, senda dragon*

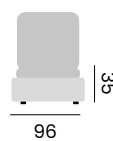
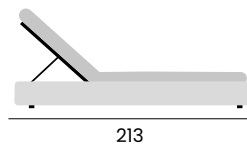





### JAMAICA

pavilion with adjustable shade, fabric olefin  
*pavilion avec écran réglable, tissu oléfine*

**96125** | alu white, textylène white, cushion light grey  
*alu blanc, textilène blanc, coussin gris clair*

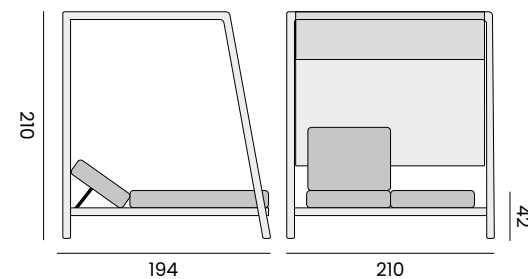

### CIRO

double sunlounger, fabric sunproof  
*lit bain de soleil double, tissu sunproof*

**96140** | alu white, cushion ecru  
*alu blanc, coussin écreu*

**96141** | alu black, cushion dark grey  
*alu noir, coussin gris foncé*

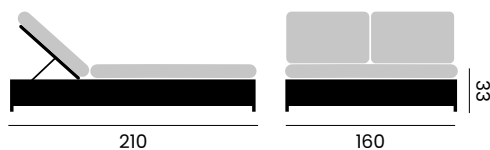



## MARCELO

sunlounger, wheels, fabric sunproof  
*lit bain de soleil, roues, tissu sunproof*

**97424** | teak, alu charcoal, cushion black  
*teck, alu charcoal, coussin noir*

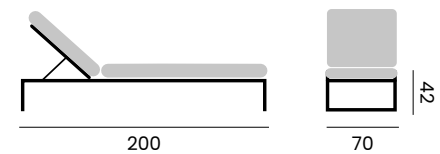

## BARCELONA

sunlounger, wheels, headrest  
 tablet sintered stone, fabric olefin  
*lit bain de soleil, roues, repose tête*  
*tablette céramique, tissu oléfine*

**97409** | alu charcoal, cushion dark grey  
*alu charcoal, coussin gris foncé*

**97410** | alu white, cushion light grey  
*alu blanc, coussin gris clair*

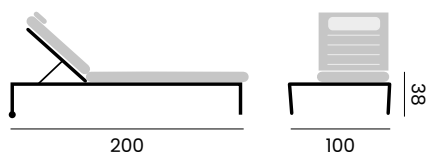

## MADRID

sunlounger, wheels, headrest, fabric olefin  
*lit bain de soleil, roues, repose tête, tissu oléfine*

**97411** | alu charcoal, cushion dark grey  
*alu charcoal, coussin gris foncé*

**97412** | alu white, cushion light grey  
*alu blanc, coussin gris clair*

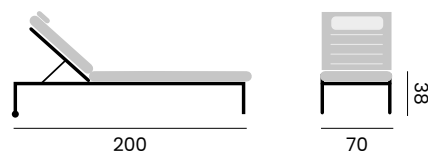

## TREMEZZO

stackable sunlounger, wheels  
*lit bain de soleil empilable, roues*

- 96101** | alu charcoal, padded textylène olefin dark grey  
*alu charcoal, textilène matelassé oléfine gris foncé*
- 96099** | alu white, padded textylène light grey  
*alu blanc, textilène matelassé gris clair*
- 97168** | alu linnen, padded textylène beige  
*alu lin, textilène matelassé beige*

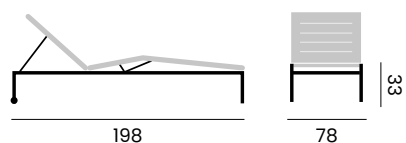

headrest for Tremezzo  
*repose tête pour Tremezzo*

- 97155** | dark grey  
*gris foncé*
- 97156** | light grey  
*gris clair*
- 97169** | beige  
*beige*



## MALLORCA

stackable sunlounger, wheels  
*lit bain de soleil empilable, roues*

- 97402** | alu white, padded textylène light grey  
*alu blanc, textilène matelassé gris clair*
- 97403** | alu black, padded textylène black  
*alu noir, textilène matelassé noir*
- 97404** | alu charcoal, padded textylène dark grey  
*alu charcoal, textilène matelassé gris foncé*

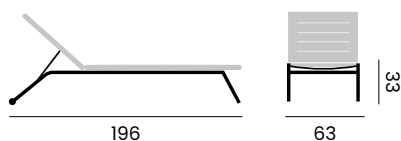

## ZARAGOZA

stackable sunlounger, wheels  
*lit bain de soleil empilable, roues*

**97234** | alu champagne, textylène light taupe  
*alu champagne, textilène taupe*

**97291** | alu white, textylène light grey  
*alu blanc, textilène gris clair*

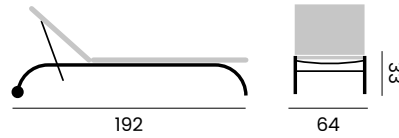

stackable sunlounger, wheels, arms  
*lit bain de soleil empilable, roues, accoudoirs*

**97565** | alu charcoal, textylène silver grey  
*alu charcoal, textilène gris argent*

**97566** | alu white, textylène light grey  
*alu blanc, textilène argent clair*

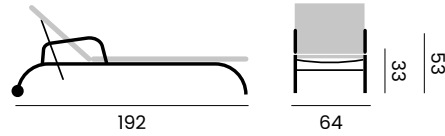

## FERRARI

sunlounger, wheels, teak armrest  
*lit bain de soleil, roues, accoudoirs en teck*

**97408** | alu charcoal, textylène dark grey  
*alu charcoal, textilène gris foncé*

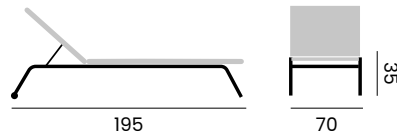

## NAVARRO

stackable sunlounger, wheels  
*lit bain de soleil empilable, roues*

- 97124** | alu white, textylène light grey  
*alu blanc, textylène gris clair*
- 97542** | alu charcoal, textylène silver grey  
*alu charcoal, textylène gris argent*

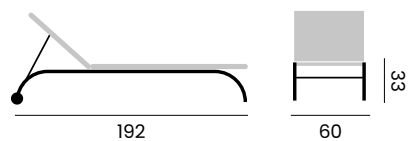

## GABANA

stackable sunlounger, wheels  
*lit bain de soleil empilable, roues*

- 94029** | alu charcoal, textylène silver grey  
*alu charcoal, textylène gris argent*
- 94030** | alu white, textylène light grey  
*alu blanc, textylène gris clair*
- 97781** | alu black, textylène black  
*alu noir, textylène noir*



## VITTORIO

sunlounger, wheels  
*lit bain de soleil, roues*

- 97010** | alu white, textylène white  
*alu blanc, textylène blanc*
- 97782** | alu black, textylène black  
*alu noir, textylène noir*
- 97298** | alu charcoal, textylène silver grey  
*alu charcoal, textylène gris argent*

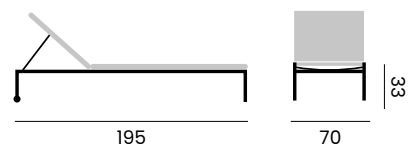



## LAS PALMAS

beacher - *transat*

- 97021** | alu charcoal, textylène black  
*alu charcoal, textilène noir*
- 97023** | alu white, textylène white  
*alu blanc, textilène blanc*
- 97236** | alu champagne, textylène light taupe  
*alu champagne, textilène taupe*
- 97292** | alu charcoal, textylène silver grey  
*alu charcoal, textilène gris argent*

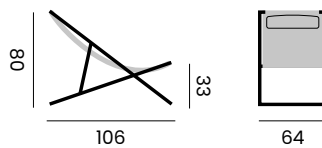

## DENIA

beacher - *transat*

- 97543** | alu charcoal, textylène silver grey  
*alu charcoal, textilène gris argent*
- 97112** | alu white, textylène light grey  
*alu blanc, textilène gris clair*

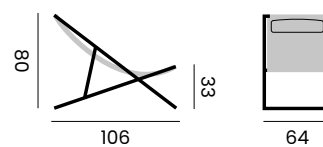



## PORTLAND

umbrella with granite base 125kg  
and protection cover  
fabric olefin 320gr, stable system, tilt

*parasol avec pied en granite 125kg  
et housse de protection  
tissu oléfine 320gr  
Système de stabilité et d'inclinaison latérale,  
molette*

**37000** | alu linnen, sand, 300x300  
*alu lin, sable, 300x300*

**37004** | alu wood look, antracite, 300x300  
*alu aspect bois, antracite, 300x300*

**37001** | alu wood look, taupe, 300x300  
*alu aspect bois, taupe, 300x300*



Utah umbrella



## UTAH

umbrella with granite base 120kg  
and protection cover  
fabric spuncrilic 250gr, stable system, tilt

*parasol avec pied en granite 120kg  
et housse de protection  
tissu spuncrilic 250gr  
Système de stabilité et d'inclinaison latérale,  
poignet*

**39013** | alu white, grey, 300x300  
*alu blanc, gris, 300x300*

**39004** | alu black, black, 300x300  
*alu noir, noir, 300x300*







## KENTUCKY

umbrella with granite base 120kg  
and protection cover  
fabric sunbrella  
stable system, new alu slide handle with crank

*parasol avec pied en granite 120kg  
et housse de protection  
tissu sunbrella  
Système de stabilité et d'inclinaison latérale  
manivelle alu glissante, molette*

**51004** | alu black, black, 300x300  
*alu noir, noir, 300x300*

## MIAMI

umbrella with granite base 120kg  
and protection cover  
fabric spuncrilic 250gr  
stable system, tilt

*parasol avec pied en granite 120kg  
et housse de protection  
tissu spuncrilic 250gr  
Système de stabilité et d'inclinaison latérale*

**58004** | alu black, black, 300x300  
*alu noir, noir, 300x300*

**58013** | alu white, grey, 300x300  
*alu blanc, gris, 300x300*

**63000** | alu wood look, beige, 300x400  
*alu aspect bois, beige, 300x400*

**63004** | alu black, black, 300x400  
*alu noir, noir, 300x400*



## VICENZA

fabric polyester 200gr  
*tissu polyester 200gr*

- 42046** | alu antracite, dark grey, 250x250  
*alu antracite, gris foncé, 250x250*
- 42043** | alu antracite, dark grey, Ø 300  
*alu antracite, gris foncé, Ø 300*



## OHIO

fabric polyester 200gr  
6 grade sun resistant  
*tissu polyester 200gr*  
*grade 6 résistant au soleil, poignet*

- 41043** | alu antracite, grey, 300x300  
*alu antracite, gris, 300x300*



## UMBRELLA WITH CRANK *PARASOL AVEC MANIVELLE*

Ø 300cm - pole Ø 38mm  
*Ø 300cm - pôle Ø 38mm*

- 61004** | alu, fabric black  
*alu, tissu noir*
- 61005** | alu, fabric taupe  
*alu, tissu taupe*
- 61013** | alu, fabric white  
*alu, tissu blanc*
- 61043** | alu, fabric grey  
*alu, tissu gris*

Ø 350cm - pole Ø 48mm  
*Ø 350cm - pôle Ø 48mm*

- 62004** | alu, fabric black  
*alu, tissu noir*
- 62005** | alu, fabric taupe  
*alu, tissu taupe*
- 62013** | alu, fabric white  
*alu, tissu blanc*
- 62043** | alu, fabric grey  
*alu, tissu gris*



## SAN DIEGO

fabric polyester 250gr  
6 grade sun resistant, tilt, LED lightning in long ribs  
*tissu polyester 250gr*  
*grade 6 résistant au soleil, système inclinaison*  
*lumières LED sur les baleines, poignet*

- 50043** | alu antracite, grey, 300x300  
*alu antracite, gris, 300x300*
- 50013** | alu white, white, 300x300  
*alu blanc, blanc, 300x300*



## DALLAS

fabric spuncrylic 250gr  
6 grade sun resistant, stable system  
oval ribs, new alu slide handle  
*tissu spuncrylic 250gr*  
*grade 6 résistant au soleil, système de stabilité*  
*baleines ovales, manivelle alu glissante, poignet*

- 43043** | alu antracite, dark grey, 300x300  
*alu antracite, gris foncé, 300x300*
- 43013** | alu white, light grey, 300x300  
*alu blanc, gris clair, 300x300*



## BOSTON

### umbrella teak, *parasol en teck*

fabric olefin 300gr, 300x300cm - pole Ø 48mm  
*tissu oléfine 300gr, 300x300cm - pôle Ø 48mm*

- 38000** | teak, fabric linnen  
*teck, tissu lin*
- 38004** | teak, fabric black  
*teck, tissu noir*



## UMBRELLA WOOD

### *PARASOL EN BOIS*

umbrella 2 parts, fabric polyester  
Ø 300cm - pole Ø 48mm  
*parasol 2 pièces, tissu polyester  
Ø 300cm - pôle Ø 48mm*

- 68005** | wood, fabric taupe  
*bois, tissu taupe*
- 68031** | wood, fabric ecru  
*bois, tissu ecru*



## UMBRELLA WOOD

### *PARASOL EN BOIS*

fabric polyester, 300x300cm - pole Ø 48mm  
*tissu polyester, 300x300cm - pôle Ø 48mm*

- 56004** | wood, fabric black  
*bois, tissu noir*
- 56005** | wood, fabric taupe  
*bois, tissu taupe*
- 56031** | wood, fabric ecru  
*bois, tissu ecru*
- 56043** | wood, fabric grey  
*bois, tissu gris*

Ø 350cm - pole Ø 48mm  
*Ø 350cm - pôle Ø 48mm*

- 55004** | wood, fabric black  
*bois, tissu noir*
- 55005** | wood, fabric taupe  
*bois, tissu taupe*
- 55031** | wood, fabric ecru  
*bois, tissu ecru*
- 55043** | wood, fabric grey  
*bois, tissu gris*

300x400cm - pole Ø 48mm  
*300x400cm - pôle Ø 48mm*

- 57004** | wood, fabric black  
*bois, tissu noir*
- 57005** | wood, fabric taupe  
*bois, tissu taupe*
- 57031** | wood, fabric ecru  
*bois, tissu ecru*
- 57043** | wood, fabric grey  
*bois, tissu gris*



**GRANITE BASE**  
**PIED EN GRANITE**

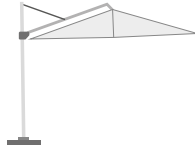

for umbrella San Diego, Ohio, Dallas, Vicenza  
with wheels  
*parasols San Diego, Ohio, Dallas, Vicenza  
avec roues*

- 58071** | dark grey 100 kg, 80x80cm  
*gris foncé 100 kg, 80x80cm*
- 58072** | light grey 100 kg, 70x70cm  
*gris clair 100 kg, 70x70cm*



**CEMENT BASE**  
**PIED EN CIMENT**

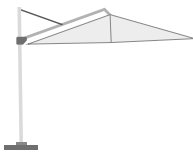

for umbrella San Diego, Ohio, Dallas, Vicenza  
with wheels  
*parasols San Diego, Ohio, Dallas, Vicenza  
avec roues*

- 58059** | cement 90 kg, 80x80cm  
*ciment 90 kg, 80x80cm*

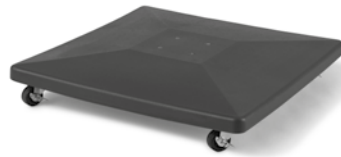

**CEMENT BASE**  
**PIED EN CIMENT**



for teak umbrella  
*pour parasols en teck*

- 58081** | cement linnen 60 kg  
*ciment lin 60 kg*
- 58082** | cement antracite 60 kg  
*ciment antracite 60 kg*



**GALVANISED STEEL BASE**  
**PIED EN ACIER GALVANISÉ**



- 58080** | dark grey 60 kg  
*gris foncé 60 kg*



**GRANITE BASE**  
**PIED EN GRANITE**



with wheels and telescope handle  
*avec roues et sa poignée télescopique*

- 58066** | black 60 kg, 50x50cm  
*noir 60 kg, 50x50cm*



**CONCRETE BASE**  
**PIED EN BÉTON**

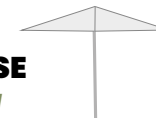

- 99401** | concrete 26 kg, Ø 50cm  
*béton 26 kg, Ø 50cm*
- 99400** | concrete 37 kg, 50x50cm, with wheels  
*béton 37 kg, 50x50cm, avec roues*



## PROTECTION COVER

### HOUSSE DE PROTECTION

- 97915** Avenatti 3-seat - 205 x 105 cm  
*Avenatti canapé 3P - 205 x 105 cm*
- 97916** Avenatti 1-seat - 105 x 105 cm  
*Avenatti fauteuil - 105 x 105 cm*
- 97931** Benito lounge seat - 92 x 152 cm  
*Benito siège lounge - 92 x 152 cm*
- 97932** Benito footrest - 92 x 67 cm  
*Benito repose-pied - 92 x 67 cm*
- 97955** Fiori 1-seat - H37 W100 L100  
*Fiori fauteuil - H37 W100 L100*
- 97956** Fiori 2-seat - H37 W100 L207  
*Fiori canapé 2P - H37 W100 L207*
- 97957** Fiori daybed - H37 W152 L205  
*Fiori lit de repos - H37 W152 L205*
- 97958** Festini 1-seat - H100 W105 L72  
*Festini fauteuil - H100 W105 L72*
- 97959** Festini 3-seat - H225 W105 L72  
*Festini canapé 3P - H225 W105 L72*
- 97960** Festini oval table - H120 W80 L31  
*Festini table ovale - H120 W80 L31*
- 97989** Rafa 1-seat  
*Rafa fauteuil*
- 97990** Rafa 3-seat  
*Rafa canapé 3P*
- 97991** Rafa element  
*Rafa unité*
- 97992** Rafa corner  
*Rafa unité de coin*
- 97993** Rafa corner 3-seat  
*Rafa unité de coin 3P*
- 97994** Rafa corner longchair  
*Rafa unité de coin chaise longue*
- 97937** Trenti sunlounger  
*Trenti lit bain de soleil*
- 97938** Juan sunlounger  
*Juan lit bain de soleil*
- 97939** Totti 1-seat  
*Totti fauteuil*
- 98205** Lagos 1-seat  
*Lagos fauteuil*
- 98206** Lagos 2-seat  
*Lagos canapé 2P*
- 98207** Lagos 3-seat  
*Lagos canapé 3P*
- 98121** Mila 1-seat  
*Mila coin gauche*
- 98122** Mila corner  
*Mila coin*
- 98123** Mila 2-seat  
*Mila canapé 3P, coin à gauche*



- 98125** Todo 3-seat, arm right  
*Todo canapé 3P, accoudoir droite*
- 98126** Todo 3-seat, arm left  
*Todo canapé 3P, accoudoir gauche*
- 98127** Todo longchair, arm left  
*Todo chaise longue, accoudoir droite*
- 98128** Todo longchair, arm right  
*Todo chaise longue, accoudoir gauche*
- 98129** Todo element  
*Todo unité*
- 98130** Todo 2-seat  
*Todo canapé 2P*
- 58056** for tables and chairs 310 x 140cm  
*tables et chaises 310 x 140cm*
- 58058** for tables and chairs 260 x 110cm  
*tables et chaises 260 x 110cm*
- 58074** for tables and chairs 230 x 130cm  
*tables et chaises 230 x 130cm*
- 58057** for lounge sets 300 x 200 cm  
*salons 300 x 200 cm*
- 58075** sunloungers 210x80x35cm  
*lits bain de soleil 210x80x35cm*
- 97933** free pole umbrella - 250 x 400 cm  
*parasols pôle libre - 250 x 400 cm*
- 99314** for all umbrella's 50 x 260 cm  
*tout les parasols 50 x 260 cm*



## PRODUCTS

### PRODUITS

- 99310** teak cleaner/renovator  
Cleans and restores the color in one treatment.  
*Nettoyant teck*  
*Nettoie et restaure la couleur en un seul traitement.*
- 99311** teak oil  
Retains the natural, light brown color of teak for longer.  
*Huile de teck*  
*Conservez la couleur brun clair et naturelle du teck plus longtemps.*
- 99308** teak protector  
Almost invisible protection that helps prevent food (coffee, ketchup, red wine, olive oil, ... from entering the Teak and causing stains.  
*Protecteur de teck*  
*Protecteur presque invisible qui aide à empêcher les aliments (café, ketchup, vin rouge, huile d'olive, ...) de pénétrer dans le teck et de causer des taches.*
- 99409** instant grey  
Brown teak gets a driftwood-gray color within the hour.  
*Gris instantané*  
*Le teck brun prend une couleur de bois flotté en une heure.*
- 99301** stainless steel cleaner  
Cleans and restores the original new appearance of Inox. Removes rust deposits.  
*Nettoyant inox*  
*Nettoie et restaure la nouvelle apparence d'origine d'Inox. Enlève les dépôts de rouille.*
- 99302** stainless steel protector  
Helps keep the new appearance of Inox for a longer period of time. Helps prevent rust deposits.  
*Protecteur d'inox*  
*Permet de conserver la nouvelle apparence d'Inox plus longtemps. Aide à prévenir les dépôts de rouille.*
- 99408** universele cleaner  
versal, non foaming cleaner for plastic, wickerwork, textile and glass.  
*Nettoyant versel*  
*Nettoyant versel non moussant pour le plastique, la vannerie, le textile et le verre.*





**FOLDING CHAIR**  
**CHAISE PLIANTE**

40x44cm - polyester

- 16068** | structure antracite  
*structure antracite*
- 16001** | structure ecru  
*structure écru*
- 16018** | linnen  
*lin*
- 16019** | black  
*noir*

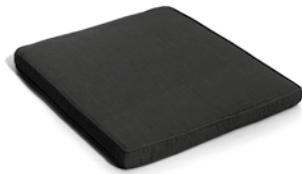

**STACKING CHAIR**  
**CHAISE EMPILABLE**

47x47cm - polyester

- 17001** | structure ecru  
*structure écru*
- 17067** | structure taupe  
*structure taupe*
- 17068** | structure antracite  
*structure antracite*
- 17018** | linnen  
*lin*
- 17019** | black  
*noir*



**RECLINING CHAIR**  
**CHAISE RÉGLABLE**

121,5x49cm - polyester

- 15001** | structure ecru  
*structure écru*
- 15014** | structure black  
*structure noir*
- 15068** | structure antracite  
*structure antracite*



**SUNLOUNGER**  
**LIT BAIN DE SOLEIL**

201x61cm - polyester

- 20001** | structure ecru  
*structure écru*
- 20067** | structure taupe  
*structure taupe*
- 20068** | structure antracite  
*structure antracite*

198x62cm, 8 cm thick,  
*198x62cm, 8cm d'épaisseur*

- 20018** | linnen  
*lin*
- 20019** | black  
*noir*



**STEAMER**  
**CHAISE LONGUE**

191x46cm - polyester

- 19001** | structure ecru  
*structure écru*
- 19014** | structure black  
*structure noir*
- 19018** | linnen  
*lin*
- 19019** | black  
*noir*



**BENCH**  
**BANC**

150x48cm - polyester

- 21001** | structure ecru  
*structure écru*
- 21068** | structure antracite  
*structure antracite*



067 taupe

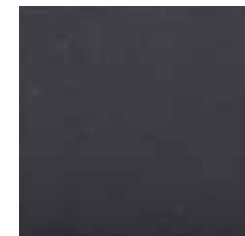

068 antracite

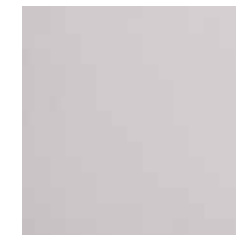

001 ecru, *écru*



014 black, *noir*



018 linnen, *lin*

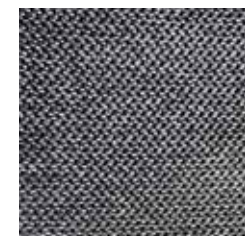

019 black, *noir*

## AGORA

### 100% dyed acrylic, *Acrylique teint à 100%*

Every Agora® solution dyed acrylic fabric collection offers an exceptional combination of strength and functionality. The fabrics are designed with the intention to be strong, durable and resistant. The water resistant finishing further improves the performance characteristics so that the fabrics are stain repellent, easy to clean and require a minimal but constant maintenance

#### Characteristics

- Teflon with stain and mildew resistant treatment
- 100% PU lamination
- Water repellent treated
- Good oil repelling properties
- Resistant to seawater
- UV resistant, with a light resistance index of 7 out of 8
- UV protection factor UPH 50+
- prevents heat and humidity condensation

#### Maintenance tips

Do not expose laminated side to UV rays or direct sunlight or any atmospheric agents. Washing in washing machine, delicate program, 30°C. Do not tumble dry. Clean stains with cloth or sponge moistened with a neutral soap solution, always on the fabric side. In case of stubborn stains a solution of < 5% bleach may be used instead. Do not dry clean nor use perchloroethylene. Iron on the fabric side only. Do not iron on the laminated side. Do not use pressure washers (Kärcher type) on fabric. It may damage the lamination and/or peel it off.

*Chaque collection de couleur acrylique teintée solution Agora® offre une combinaison exceptionnelle de force et de fonctionnalité. Les couleurs sont conçues avec l'intention d'être fortes, durable et résistant. La finition résistante à l'eau améliore encore les caractéristiques de performance de sorte que les couleurs sont anti-taches, faciles à nettoyer et nécessitent un entretien minimal mais constant.*

#### Les caractéristiques

- Téflon avec traitement résistant aux taches et à la moisissure Stratification
- 100% PU Traitement déperlant
- Bonnes propriétés oléophobes
- Résistant à la saleté
- Résistant aux UV, avec un indice de résistance à la lumière de 7 sur 8
- Facteur de protection UV UPH 50+
- empêche la condensation de chaleur et d'humidité

#### Conseils d'entretien

*N'exposez pas la face laminée aux rayons UV ou à la lumière directe du soleil ou à tout agent atmosphérique.. Lavage en machine à laver, programme délicat, 30 ° C Ne pas sécher en machine. Nettoyez les taches avec une éponge imbibée d'un savon neutre solution, toujours du côté de la couleur. En cas de taches tenaces, une solution d'eau de Javel <5% peut être utilisée à la place. Ne pas nettoyer à sec ni utiliser de perchloréthylène. Repasser du côté couleur uniquement. Ne pas repasser du côté laminé. N'utilisez pas de nettoyeurs haute pression (type Kärcher) sur couleur. Cela pourrait endommager la plastification et / ou la décoller.*

## OLEFIN

### 100% Olefin, 190 grams m<sup>2</sup>, *100% d'oléfine, 190 grammes m<sup>2</sup>*

#### Characteristics

- Colorfast / sunlight resistant
- Lightfastness 7/8 (high)
- Light Water-repellent
- Hardwearing / strong
- Quick drying
- Breathable
- Low static / does not peel
- Resistant to influences of chemicals, dew, perspiration, rot and weather.
- Dirt resistant
- Very comfortable
- Light (Olefin fibers have the lowest specific gravity of all fibers)

#### Maintenance tips

Hand wash. Most stains can easily be removed by dabbing with lukewarm water When you have washed the fabric, let it dry on the line. Olefin does not need to be ironed.

#### Les caractéristiques

- Colorfast / résistant au soleil
- Résistance à la lumière 7/8 (haute)
- Hydrofuge léger
- Résistant / fort

- Séchage rapide
- Respirant
- Basse statique / ne pèle pas
- Résistant aux influences des produits chimiques, de la rosée, de la transpiration, de la pourriture et des intempéries.
- Résistant à la saleté
- Très confortable
- Légère (les fibres d'oléfine ont la densité la plus basse de toutes les fibres)

#### Conseils d'entretien

*Lavage à la main. La plupart des taches peuvent facilement être enlevées en tamponnant avec de l'eau tiède. Lorsque vous avez lavé le tissu, laissez-le sécher sur la ligne. Oléfine n'a pas besoin d'être repassé*

## SUNBRELLA

### 100% dyed acrylic, *Acrylique teint à 100%*

#### Characteristics

- Rot and mold resistant
- Water repellent
- Resistant to seawater
- No damage or discoloration due to UV rays
- Easy to clean; brush a soap with water
- Breathable, does not become hot and does not stick
- Does not peel and does not become hard during use

#### Maintenance tips

Hand wash. Most stains can easily be removed by dabbing with lukewarm water. If the fabric has been washed, it must be dried on the line. Sunbrella does not need to be ironed.

#### Les caractéristiques

- Anti pourriture et moisissure
- Hydrofuge
- Résistant à l'eau de mer
- Aucun dommage ou décoloration dû aux rayons UV
- Facile à nettoyer; badigeonner un savon avec de l'eau
- Respirant, ne chauffe pas et ne colle pas
- Ne pèle pas et ne devient pas dur pendant l'utilisation

#### Conseils d'entretien

*Lavage à la main. La plupart des taches peuvent facilement être enlevées en tamponnant avec de l'eau tiède. Si le tissu a été lavé, il doit être séché sur la ligne. Sunbrella n'a pas besoin d'être repassé.*

## SUNPROOF

### 100% Sunproof Olefin, 238 grams m<sup>2</sup>, *Oléfine 100% solaire, 238 grammes m<sup>2</sup>*

#### Characteristics

- Colorfast
- Lightfastness high 8
- Water repellent
- Hardwearing / strong
- Quick drying
- Breathable
- Dirt resistant
- Comfortable

#### Maintenance tips

Hand wash. Most stains can easily be removed by dabbing with clear lukewarm water and a soft brush. For stubborn stains, we recommend using a mild soap. When the fabric is washed, let it dry in the open air. The Sunproof fabric does not need to be ironed

#### Les caractéristiques

- Grand teint
- Résistance à la lumière élevée 8
- Hydrofuge
- Résistant / fort
- Séchage rapide
- Respirant
- Résistant à la saleté
- Confortable

#### Conseils d'entretien

*Lavage à la main. La plupart des taches peuvent facilement être enlevées en tamponnant avec de l'eau claire tiède et une brosse douce. Pour les taches tenaces, nous vous recommandons d'utiliser un savon doux Lorsque le tissu est lavé, laissez-le sécher à l'air libre. Le tissu Sunproof n'a pas besoin d'être repassé*



## MARIOSIRTORI SIESTA

100% Solution dyed polypropylene, 720 g/m<sup>2</sup>

100 % polypropylène teinté dans la masse, 720 g/m<sup>2</sup>

### Characteristics

- OUTperform series in solution dyed Polypropylene
- 100% Recyclable fabrics
- Martindale and Pilling suitable for upholstery
- Anti-allergic
- Resistant to fungus, bacteria, sunlight, humidity, chlorine, food stains and sweat
- Compatible with delicate baby skin
- Eco-friendly (low energy for cleaning, long lasting life cycle, easy to use)
- Thermoregulating and transpiring
- Resists years of washing, no odor absorption, washing only at 30° cycle and with small detergent
- Quick drying, very comfortable and lightweight, easy to clean
- Bleach cleanable by using a very small quantity of bleach mixed up with water; it is very important that the bleach is properly removed with water and that the fabric is carefully dried up before sun light exposure.

### Maintenance tips

Machine wash at 30 degrees Celsius and air dry (do not iron or tumble dry)

### Les caractéristiques

- Série OUTperform en polypropylène teinté dans la masse
- Tissus 100% recyclables
- Martindale et Pilling adaptés au rembourrage
- Anti allergène
- Résistant aux champignons, aux bactéries, au soleil, à l'humidité, au chlore, aux taches de nourriture et à la sueur
- Compatible avec la peau délicate de bébé
- Respectueux de l'environnement (faible consommation d'énergie pour le nettoyage, cycle de vie longue durée, facile à utiliser)
- Thermorégulatrice et transpirante
- Résiste à des années de lavage, pas d'absorption des odeurs, lavage uniquement au cycle 30° et avec une petite lessive
- Séchage rapide, très confortable et léger, facile à nettoyer
- Nettoyable à l'eau de Javel en utilisant une très petite quantité d'eau de Javel mélangée à de l'eau ; il est très important que l'eau de Javel soit correctement éliminée avec de l'eau et que le tissu soit soigneusement séché avant l'exposition à la lumière du soleil.

### Conseils d'entretien

Lavage en machine à 30 degrés Celsius et séchage à l'air libre (ne pas repasser ni sécher au sèche-linge)

## QUICK DRY FOAM, MOUSSE À SÉCHAGE RAPIDE

- anti microbial
- volatile organic compound
- environmentally friendly
- high durability
- antimicrobien
- composé organique volatil écologique
- Haute durabilité

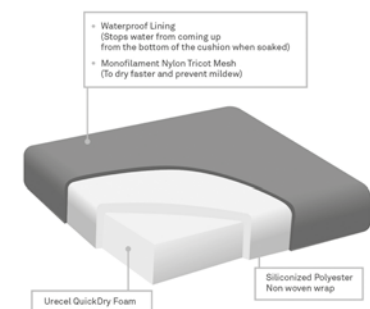

Cushion cover (Top View)

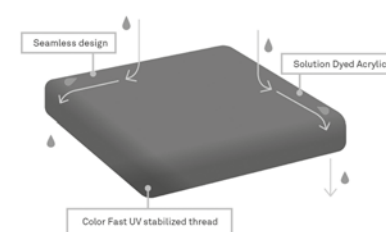

Cushion cover (Bottom View)

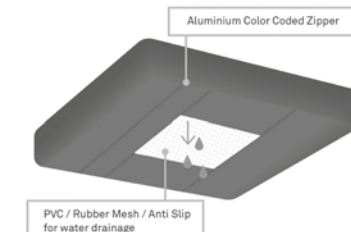





### **Gescova NV**

Head office  
Albertstraat 34  
BE-8560 Wevelgem - BELGIUM

T +32 56 42 79 03  
info@gescova.com  
www.gescova.com

### **Gescova France**

Olivier DEREUX  
od@lavilladolivier.com - T. +33 6 47 96 04 38

Flora DEREUX  
flora@lavilladolivier.com - T. +33 6 50 00 67 74

### **Gescova Germany**

Robert heijligers  
robert@interior-agency.eu - T. +49 172 319 8028

### **Gescova Spain**

Alberto Alonso Durand  
alberto@grupo-grancasa.es - T. +34 91 666 72 23

### **Gescova Finland**

Hannu Saarinen  
hannu@ganos.fi - T. +358 400 648639

